



HM Government

fire safety risk assessment

transport premises and facilities

Copyright in the contents, the cover, the design and the typographical arrangement rests with the Crown. This document/publication is value added. If you wish to re-use this material, please apply for a Click-Use Licence for value added material at www.opsi.gov.uk/click-use/system/online/pLogin.asp

Alternatively, applications can be sent to:

OPSI, Information Policy Team, St Clements House, 2-16 Colegate, Norwich NR3 1BQ

Fax: 01603 723000

E-mail: HMSOlicensing@cabinet-office.x.gsi.gov.uk

This publication has been approved by Ministers and has official status. The contents of this publication may be reproduced free of charge in any format or medium for the purposes of private research and study or for internal circulation within an organisation. This is subject to the contents being reproduced accurately and not in a way that implies official status. Any publisher wishing to reproduce the content of this publication must not use or replicate the HMG logo or replicate the official version's style and appearance, including the design, and must not present their publication as being an official publication as this may confuse the public. The reproduced material must be acknowledged as Crown copyright and the title of the publication specified. HM Government does not accept any responsibility for the accuracy and the comprehensiveness of any other versions.

Any other use of the contents of this publication would require a copyright licence. Further information can be obtained from www.opsi.gov.uk

Department for Communities and Local Government Publications
PO Box 236
Wetherby
West Yorkshire
LS23 7NB
Tel: 0870 830 7099
Fax: 0870 1226 237
Textphone: 0870 1207 405
E-mail: communities@twoten.press.net

This document is also available on the DCLG website: www.firesafetyguides.communities.gov.uk

Reference number: 05 FRSD 03338 (k)

Published by the Department for Communities and Local Government, Eland House, Bressenden Place
London SW1E 5DU, February 2007.

© Crown copyright 2007.

Printed on material containing 100% post-consumer waste (text),
75% post-consumer waste and 25% ECF pulp (cover).

ISBN-13: 978 1 85112 825 9

Contents

How to use this guide	2
Preface	3
Introduction	4
Part 1 Fire risk assessment	11
Step 1 Identify fire hazards	15
Step 2 Identify people at risk	18
Step 3 Evaluate, remove, reduce and protect from risk	19
Step 4 Record, plan, inform, instruct and train	38
Step 5 Review	44
Part 2 Further guidance on fire risk assessment and fire precautions	47
Section 1 Further guidance on fire risks and preventative measures	49
Section 2 Further guidance on fire-detection and warning systems	58
Section 3 Further guidance on firefighting equipment and facilities	63
Section 4 Further guidance on escape routes	70
Section 5 Further guidance on emergency escape lighting	111
Section 6 Further guidance on signs and notices	113
Section 7 Further guidance on recording, planning, informing, instructing and training	116
Section 8 Quality assurance of fire-protection equipment and installation	131
Appendix A1 Example of fire safety maintenance checklist	132
Appendix A2 Example form for recording significant findings	135
Appendix B Technical information on fire-resisting separation, fire doors and door fastenings	136
Appendix C Historic buildings	143
Appendix D Glossary	145
References	150
Index	155

How to use this guide

This guide is divided into two parts:

- **Part 1** explains what fire risk assessment is and how you might go about it. Fire risk assessment should be the foundation for all the precautions in your premises.
- **Part 2** provides further guidance on fire precautions. The information is provided for you and others for reference purposes during your fire risk assessment or when you are reviewing your precautions.

The appendices provide example checklists, some detailed technical information on fire-resisting elements and advice on historic buildings.

This guide is one from a series of guides listed on the back cover.

The rest of this introduction explains how the law applies.

Technical terms are explained in the glossary and references to other publications that are listed at the end of the guide are identified by a superscript number in the text.

In this guide, reference is made to British Standards and standards provided by other bodies. The standards referred to are intended for guidance only and other standards could be used. Reference to any particular standard is not intended to confer a presumption of conformity with the requirements of the Regulatory Reform (Fire Safety) Order 2005 (the Order).¹

The level of necessary safety (or service) must be dictated by the findings of your risk assessment, so you may need to do more or less than that specified in any particular standard referred to. You must be prepared to show that what you have done complies with any requirements or prohibitions of the Order¹ irrespective of whether you have relied on a particular standard.

Preface

This guidance gives advice on how to avoid fires and how to ensure people's safety if a fire starts. Why should you read it?

- Fire kills. In 2004 (England and Wales) fire and rescue services responded to over 33,400 fires in non-domestic facilities. These fires killed 38 people and injured over 1,300.
- Fire costs money. The costs of a serious fire can be high: following a fire, both the transport and business operations of your organisation can be seriously or permanently affected. In 2004, the costs as a consequence of fire, including property losses, human casualties and lost business, were estimated at £2.5 billion.

This guide applies to England and Wales only. It does not set prescriptive standards, but provides recommendations and guidance for use when assessing the adequacy of fire precautions in your premises and facilities. Other fire risk assessment methods may be equally valid to comply with fire safety law. The guide also provides recommendations for the fire safety management of the premises.

Your existing fire safety arrangements may not be the same as the recommendations referenced in this guide but, as long as you can demonstrate that they meet an equivalent standard of fire safety, they are likely to be acceptable. If you decide that your existing arrangements are not satisfactory, there may be other ways to comply with fire safety law. This means there is no obligation to adopt any particular solution in this guide if you prefer to meet the relevant requirements in some other way.

Where the building or facilities have been recently constructed or significantly altered, the fire-detection and warning arrangements, escape routes and facilities for the fire and rescue service should have been designed, constructed and installed in accordance with current building regulations. In such cases, it is likely that these measures will be satisfactory, as long as they continue to be properly maintained and no significant increase in risk has been introduced.

In addition, other legislation, including local authority Acts, may have imposed additional requirements for fire precautions.

This guide should not be used to design fire safety for new buildings at your premises or where alterations are proposed as they may be subject to building regulations. However, it can be used to develop the fire safety strategy for the building.

Introduction

WHO SHOULD USE THIS GUIDE?

This guide is for all employers, managers, occupiers and owners of premises and all others who have responsibility for the management of fire safety on a day-to-day basis in transport premises and facilities. It tells you what you have to do to comply with fire safety law and helps you carry out a fire risk assessment and identify the general fire precautions you need to have in place.

This guide is intended for transport premises and facilities, such as:

- airport terminals (passenger and freight);
- ferry/shipping ports (passenger and freight);
- rail (surface – train/light rail/tram – and sub-surface) terminals, stations and platforms;
- bus/coach terminals and stations;
- transport interchanges;
- tunnels (road and rail); and
- similar premises not included in the above list.

The above list of transport facilities indicates the wide range of application of this guide. It is intended that the guidance for assessing the fire risk is appropriate to all the transport facilities, ranging from the smallest and least complex to the largest and most complex, falling within this category. The fire safety measures should be matched, carefully, to the level of fire risk identified within the transport facility.

It is likely that many of the owners and/or operators of transport facilities will have well documented and practised general health and safety risk assessment policies and procedures that may include fire safety issues. This guide is not intended to replace those policies/procedures: it provides a benchmark against which the fire safety measures can be assessed to ensure compliance with the Order.¹

This guide does not apply to the offices and shops within the above premises – appropriate guidance should be sought from the relevant guide listed on the back cover – nor does it apply to fire safety in vehicles used as modes of transport (e.g. cars, buses, trains, aircraft). Where the facility adjoins, contains or connects to other occupancies or complexes, such as shopping malls, hotels or places of public entertainment (e.g. an airport terminal incorporating a hotel and/or retail premises), this guide applies to those elements relating directly to the transport premises and facilities. In such cases, consultation with the responsible persons for the other facilities and/or the centre as a whole will be necessary as part of an integrated risk assessment strategy for the entire complex.

The guide does account for the effect of a fire in a mode of transport, office, shop, etc. in or near the premises.

Also, where you handle and store flammable materials and substances, it will help you to take account of these in your risk assessment and will help you determine the necessary precautions to take to minimise the likelihood of them being involved in a fire.

This guide has been written to provide guidance for a responsible person, to help them carry out fire risk assessment in transport premises and facilities. If you read the guide and decide that you are unable to apply the guidance, then you should seek expert advice from a competent person. More complex premises will probably need to be assessed by a person who has had comprehensive training or experience in fire safety. However, this guide can also be used for multi-occupied buildings to address fire safety issues in their individual occupancies.

The guide may also be used for:

- employees;
- employee-elected representatives;
- trade union-appointed health and safety representatives;
- enforcing authorities; and
- all other people who have a role in fire safety in transport premises and facilities.

If your premises are listed as of historic interest, refer to Appendix C.

Fire safety is just one of many safety issues management must address to minimise the risk of injury or death to staff and the public. Unlike most of the other safety concerns, fire has the potential to injure or kill large numbers of people very quickly. This guide is concerned only with fire safety, but many of the measures discussed here will impact on other safety concerns and vice versa. It is recognised that these differing safety demands can sometimes affect one another and management should consult other interested agencies, such as the Health and Safety Executive (HSE) and the Office of Rail Regulation (ORR), where necessary, to confirm that they are not contravening other legislation/guidance.

You can get advice about minimising business fire losses from your insurer.

THE FIRE SAFETY ORDER

Previous general fire safety legislation

The Order¹ replaces all previous fire safety legislation applicable to transport premises and facilities except the Fire Precautions (Sub-surface Railway Stations) Regulations 1989,² as amended in 1994.³ Any fire certificate issued under the Fire Precautions Act 1971⁴ will cease to have any effect. If a fire certificate has been issued in respect of your premises or if the premises were built to recent building regulations, as long as you have made no material alterations and all the physical fire precautions have been properly maintained, then it is unlikely that you will need to make any significant improvements to your existing fire-protection provisions to comply with the Order.¹ However, you must still carry out a fire risk assessment and keep it up to date to ensure that all the fire precautions in your premises remain current and adequate.

If you have previously carried out a fire risk assessment under the Fire Precautions (Workplace) Regulations 1997,⁵ as amended in 1999,⁶ and this assessment has been regularly reviewed, then you will need to revise that assessment, taking into account the wider scope of the Order¹ as described in this guide.

Your premises may also be subject to the provisions of a licence or registration (e.g. under the Licensing Act 2003⁷), and the fire authority may wish to review your risk assessment as part of the licensing approval process. Fire safety conditions within your premises licence should not be set by a licensing authority where the Order¹ applies.

Your premises may also be or become subject to other relevant legislation, such as any European Directives covering fire safety in your transport premises, be it an air, land (road or rail) or sea facility. Where this is the case, you should seek advice from your relevant enforcing authority.

Background

The Order¹ applies in England and Wales. It covers general fire precautions and other fire safety duties which are needed to protect 'relevant persons' in case of fire in and around most 'premises'. The Order¹ requires fire precautions to be put in place 'where necessary' and to the extent that it is reasonable and practicable in the circumstances of the case.

Responsibility for complying with the Order¹ rests with the 'responsible person'. In a workplace, this is the employer and any other person who may have control of any part of the premises, e.g. the occupier, owner or manager. In all other premises the person or people in control of the premises will be responsible. If there is more than one responsible person in any type of premises, they must take all reasonable steps to co-operate and co-ordinate with each other.

If you are the responsible person, you must carry out a fire risk assessment which must focus on the fire safety of all 'relevant persons' who could be affected by a fire. It should pay particular attention to those at special risk, such as disabled people or those with special needs, children, and non-English-speaking users of the premises. It must include consideration of any dangerous substance liable to be on the premises. Your fire risk assessment will help you identify risks that can be removed or reduced, and decide the nature and extent of the general fire precautions you need to take.

More complex facilities may need to be assessed by a person who has comprehensive training or experience in fire risk assessment with input from a number of sources, including local staff or their safety representatives. However, this guide can be applied to individual parts of the facility to address fire safety issues within individual occupancies by a person with the appropriate level of formal training or experience relevant to managing that specific premises or facility.

If your organisation employs five or more people, your premises are licensed or an alterations notice is in force, you must record the significant findings of the assessment. It is good practice to record your significant findings in any case.

There are other fire safety duties with which you need to comply:

- **You must** appoint one or more competent persons, depending on the size and use of your premises and facilities, to carry out any of the preventative and protective measures required by the Order¹ (you can nominate yourself for this purpose). A competent person is someone with enough training, knowledge, experience and other qualities to be able to implement these measures properly.
- **You must** provide your employees with clear and relevant information on the risks to them identified in the fire risk assessment, about the measures you have taken to prevent fires, and how these measures will protect them if a fire breaks out.
- **You must** consult your employees (or their elected representatives) about nominating people to carry out particular roles in connection with fire safety and about proposals for improving the fire precautions.
- **You must** inform non-employees, such as temporary or contract workers, of the relevant risks to them, and provide them with information about who are the nominated competent persons and about the fire safety procedures for the premises.
- **You must** co-operate and co-ordinate with other responsible persons in your transport premises, inform them of any significant risks you find and how you will seek to reduce/control those risks that might affect the safety of their employees.
- **You must** provide the employer of any person from an outside organisation who is working in your premises (e.g. a contractor providing temporary staff) with clear and relevant information on the risks to those employees and the preventative and protective measures taken. You must also provide those employees with appropriate instructions and relevant information about the risks to them.
- If you are not the employer but have control of premises which contain more than one workplace, **you are also responsible** for ensuring that the requirements of the Order¹ are complied with in those parts over which you have control.

- **You must** consider the presence of any dangerous substances and the fire risk that this presents to relevant persons from fire.
- **You must** establish a suitable means of contacting the emergency services and provide them with any relevant information about dangerous substances.
- **You must** provide appropriate information, instruction and training to your employees, during their normal working hours, about the fire precautions in your workplace, when they start working for you (induction training) and from time to time throughout the period that they work for you.
- **You must** ensure that the premises, facilities and any equipment provided in connection with firefighting, fire detection and warning, or emergency routes and exits are all covered by a suitable system of maintenance, and are maintained by a competent person so that they are in an efficient state, in efficient working order and in good repair.
- **Your employees must** co-operate with you to ensure that the workplace is safe from fire and its effects, and they must not do anything that will place themselves or other people at risk.

The above outline some of the main requirements of the Order.¹ The rest of this guide will explain how you can meet these requirements.

Responsibilities for leasing and for shared use

Some premises or structures may be leased as an empty and unsupervised facility. The fire safety responsibilities of those leasing the building or structure (and, therefore, in charge of the activities conducted within the building or structure) and those of the owner/lessee need to be established as part of the contract of hire.

In some large premises, part of the premises may be leased to other organisations for a purpose other than that of the primary function of the premises (e.g. concessions within an airport terminal). The fire safety responsibilities of these organisations and those for the remainder of the building need to be established as part of the formal contract between the various parties.

The responsible person for unique or occasional specific activities will need to be clearly established and documented, and their legal duties made clear to them. In particular, and where necessary, the responsible person will need to take account of their own lack of familiarity with the layout of the premises, and the duties of other responsible persons within the premises.

Who enforces the Fire Safety Order?

The local fire and rescue authority (the fire and rescue service) will enforce the Order¹ in most premises. The exceptions are:

- Crown-occupied/owned premises, where Crown fire inspectors will enforce;
- premises within armed forces establishments, where the defence fire and rescue service will enforce; and
- certain specialist premises including construction sites, ships (under repair or construction) and nuclear installations, where the HSE or the local authority will enforce;
- sports grounds and stands designated as needing a safety certificate by the local authority, where the local authority will enforce.

The enforcing authority will have the power to inspect your premises to check that you are complying with your duties under the Order.¹ They will look for evidence that you have carried out a suitable fire risk assessment and have acted upon the significant findings of that assessment. If you are required to record the outcome of the assessment, they will expect to see a copy.

If the enforcing authority is dissatisfied with the fire risk assessment or the action you have taken, they may issue an enforcement notice that requires you to make certain improvements, or, in extreme cases, a prohibition notice that restricts the use of all or part of your premises until improvements are made.

If you are making changes to your premises, you should also consult your local licensing authority.

If your premises are considered by the enforcing authority to be or have the potential to be high risk, they may issue an alterations notice that requires you to inform them before you make any changes to your premises or the way they are used.

Failure to comply with any duty imposed by the Order¹ or any notice issued by the enforcing authority is an offence. You have a right of appeal to a magistrates' court against any notice issued. Where you agree that there is a need for improvements to your fire precautions but disagree with the enforcing authority on the technical solution to be used (e.g. what type of fire alarm system is needed), you may agree to refer this for independent determination.

If, having read this guide, you are in any doubt about how fire safety law applies to you, contact the fire safety office at your local fire and rescue service.

If your premises were in use before 2006, then they may have been subject to the Fire Precautions Act 1971⁴ and/or the Fire Precautions (Workplace) Regulations.^{5,6} Where the layout (means of escape) and other fire precautions have been assessed by the fire and rescue service to satisfy the guidance that was then current, it is likely that your premises already conform to many of the recommendations here, providing you have undertaken a fire risk assessment as required by the Fire Precautions (Workplace) Regulations.^{5,6}

New buildings or significant building alterations should be designed to satisfy current building regulations⁸ and/or other relevant legislation (e.g. the Fire Precautions (Sub-surface Railway Stations) Regulations^{2,3} or European Directives) which addresses the fire precautions for your premises. However, you will still need to undertake a fire risk assessment, or review your existing assessment (and act on your findings), to comply with the Order.¹

Part 1 Fire risk assessment

MANAGING FIRE SAFETY

Good management of fire safety is essential to ensure that fires are unlikely to occur; that if they do occur they are likely to be controlled or contained quickly, effectively and safely; or that, if a fire does occur and grow, everyone in your premises is able to escape to a place of total safety easily and quickly.

Fire safety management is an organisational issue where the responsible person undertakes one role within the overall fire safety management process. This process relies on the practical knowledge of staff and their health and safety representatives in undertaking the many different roles and responsibilities required. For most transportation premises, fire safety management may be managed as part of the health and safety management system. Further guidance is provided in BS 5588-12¹⁵ and from the HSE (HSG65).⁹

The risk assessment that you must carry out will help you to ensure that your fire safety procedures, fire prevention measures and fire precautions (plans, systems and equipment) are all in place and working properly. The risk assessment should identify any issues that need attention.

You must consult the health and safety representative of your organisation on any issues arising from your risk assessment.

Fire risk assessment in the transport industry is often undertaken by specialists either in-house or brought in from external sources. Effective fire safety management should include the identification and implementation of the roles and responsibilities for the ongoing review and management of fire safety after the fire risk assessments have been completed. This is particularly important when the risk assessment will then be managed by local managers.

What is a fire risk assessment?

A fire risk assessment is an organised and methodical evaluation of your premises and facilities, the activities undertaken there and the likelihood that a fire could start and cause harm to those in and around the premises.

The aims of the fire risk assessment are:

- to identify the fire hazards;
- to reduce the risk of those hazards causing harm to as low as reasonably practicable; and
- to decide what physical fire precautions and management arrangements are necessary to ensure the safety of people in your premises if a fire does start.

The term 'where necessary' (see Glossary) is used in the Order,¹ therefore when deciding what fire precautions and management arrangements are necessary you will need to take account of this definition.

The terms 'hazard' and 'risk' are used throughout this guide and it is important that you have a clear understanding of how these should be used.

- **Hazard:** anything that has the potential to cause harm.
- **Risk:** the chance of that harm occurring.

If your organisation employs five or more people, or your premises are licensed or an alteration notice requiring it is in force, then significant findings of the fire risk assessment, the actions to be taken as a result of the assessment and details of anyone especially at risk must be recorded. You will probably find it helpful to keep a record of the significant findings of your risk assessment even if you are not required to do so.

How do you carry out a fire risk assessment?

A fire risk assessment will help you to determine the chances of a fire starting and the dangers from fire that your premises present for the people who use them and any person in the immediate vicinity. The assessment method suggested in this guide shares the same approach as that used in general health and safety legislation and can be carried out either as part of a more general health and safety risk assessment or as a separate exercise. As you move through the steps there are checklists to help you.

Before you start your fire risk assessment, take time to prepare, and read through the rest of Part 1 of this guide.

Much of the information for your fire risk assessment will come from the knowledge that your employees, colleagues and representatives have of the transport premises and facilities, as well as information given to you by people who have responsibility for other parts of the premises. A tour of your premises will probably be needed to confirm, amend or add detail to your initial views.

It is important that you carry out your fire risk assessment in a practical and systematic way and that you allocate enough time to undertake a suitable and sufficient assessment. It must take the whole of your premises into account, including the exterior of the premises and outdoor facilities and operations. Make sure to cover any rooms and areas that are rarely used or are unoccupied. If your premises are small you may be able to assess them as a whole. In some premises you may find it helpful to divide them into a series of assessment areas using natural boundaries, e.g. public spaces (such as ticketing areas, waiting lounges and platforms) and back-of-house areas (such as offices, stores, staff amenities, maintenance shops, etc.), as well as corridors, stairways and external routes.

If your premises are in a multi-use complex, then the information on hazard and risk reduction will still be applicable to you. However, any alterations to the use or structure of your individual facility will need to take account of the overall fire safety arrangements in the building.

If your premises form part of a multi-use complex, then the measures provided by other occupiers may have a direct effect on the adequacy of the fire safety measures in your premises.

Under health and safety law (enforced by the ORR, HSE or the local authority) you are required to carry out a risk assessment in respect of any work processes in your workplace and to take or observe appropriate special, technical or organisational measures. If your health and safety risk assessment identifies that these processes are likely to involve the risk of fire or the spread of fire, then you will need to take this into account during your fire risk assessment under the Order,¹ and prioritise actions based on the level of risk.

You need to appoint one or more competent persons (this could be you) to carry out any of the preventative and protective measures needed to comply with the Order.¹ In large and complex transportation premises such as multi-mode interchanges, this person may be an appropriately trained full-time employee, e.g. a duty/shift manager, station/airport manager or, where appropriate, a third party.

Your fire risk assessment should demonstrate that, as far as is reasonable, you have considered the needs of all relevant persons, including persons with special needs.

Figure 1 shows the five steps you need to take to carry out a fire risk assessment.

FIRE SAFETY RISK ASSESSMENT

1 Identify fire hazards

Identify:

Sources of ignition
Sources of fuel
Sources of oxygen

2 Identify people at risk

Identify:

People in and around the premises
People especially at risk

3 Evaluate, remove, reduce and protect from risk

Evaluate the risk of a fire occurring
Evaluate the risk to people from fire
Remove or reduce fire hazards
Remove or reduce the risks to people

- Detection and warning
- Firefighting
- Escape routes
- Lighting
- Signs and notices
- Maintenance

4 Record, plan, inform, instruct and train

Record significant findings and action taken
Prepare an emergency plan
Inform and instruct relevant people; co-operate and co-ordinate with others
Provide training

5 Review

Keep assessment under review
Revise where necessary

Remember to keep your fire risk assessment under review.

Figure 1: The five steps of a fire risk assessment

STEP 1 IDENTIFY FIRE HAZARDS

For a fire to start, three things are needed:

- a source of ignition;
- fuel; and
- oxygen.

If any one of these is missing, a fire cannot start. Taking measures to avoid the three coming together will therefore reduce the chances of a fire occurring.

The remainder of this step will advise on how to identify potential ignition sources, the materials that might fuel a fire and the oxygen supplies that will help it burn.

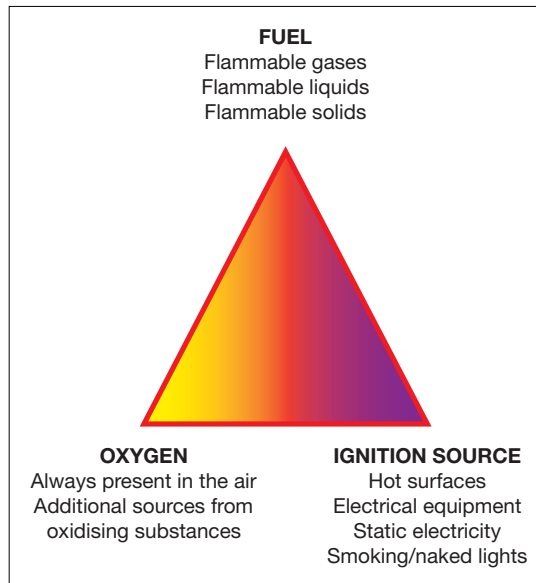

Figure 2: The fire triangle

1.1 Identify sources of ignition

You can identify the potential ignition sources in your premises by looking for possible sources of heat, which could get hot enough to ignite material found in your premises. These sources could include:

- naked flames, e.g. gas or liquid fuel open-flame equipment and blowtorches;
- sources of high energy, e.g. heat/power generators, electro-magnetic equipment, transformers and overhead power lines;
- surfaces with raised temperatures, e.g. fire and heating appliances, vehicle exhausts and lighting equipment;
- transmission of thermal radiation, e.g. heaters;
- hot combustion products;
- sources of static electricity, e.g. static discharge during refuelling operations;
- mechanical friction, e.g. vehicle brakes, cutting and grinding equipment, baggage conveyors;
- natural phenomena, e.g. lightning; and
- human actions or activities, i.e. deliberate fire raising (e.g. arson and terrorism) or accidental fires as a result of an act of neglect or omission (e.g. smoking in hazardous areas and hot working without checking the area for combustible materials).

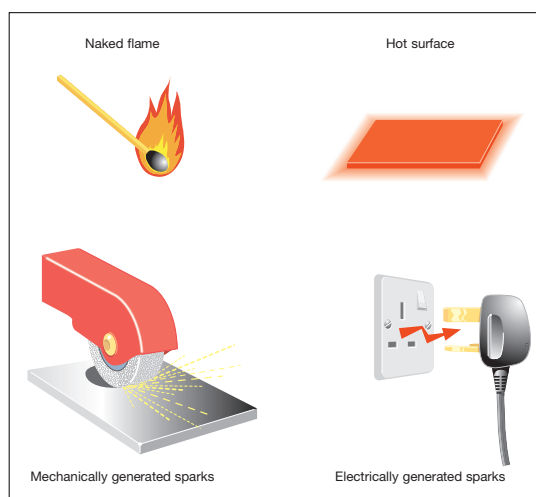

Figure 3: Sources of ignition

You should also consider potential sources of ignition arising from external activities, e.g. a bus or train on fire arriving in a station.

As you become familiar with your transport premises and facilities, you will become aware of problems that, if not controlled, can result in ignition.



*Figure 4: Fire in a storeroom (hot works)
(courtesy of Network Rail)*



*Figure 5: Signal box fire (arson)
(courtesy of Network Rail)*

Changes to the premises may be occurring on a more or less continuous basis, requiring constant monitoring of the risk from ignition sources. In all cases, the potential source of ignition needs to be considered in conjunction with the proximity and nature of any potential sources of fuel.

Additional knowledge of ignition sources can be obtained from past experience and knowledge of records of fires in premises similar to your own.

1.2 Identify sources of fuel

Anything that will burn is fuel for a fire. You need to look for materials that will burn reasonably easily and are in sufficient quantity to provide fuel for a fire, or cause it to spread to another fuel source. Some of the most common 'fuels' found in transport premises are:

- modes of transport, e.g. cars, buses, planes and trains;
- flammable liquids and solvents, e.g. oil, diesel, petrol, aircraft fuels and paraffin;
- flammable gases, e.g. LPG, propane and natural gas;
- fuels and lubricants, e.g. vehicle, generator and mechanical equipment lubricants;
- stored goods, e.g. foodstuffs containing sugar and oil plus paper products;
- plastics and rubber, e.g. flammable foam-filled furniture and flammable expanded plastic display materials;
- waste products, e.g. finely shredded paper, litter, rubbish and packaging materials;
- plastic and timber storage aids;

- combustible insulation; and
- fixtures and fittings, e.g. textiles and soft furnishings, passenger baggage and upholstered furniture.

You should consider the materials used to line or decorate walls and ceilings, e.g. polystyrene ceiling tiles, paint build-up, advertising boards, carpet tiles, fixtures and fittings, plus any materials brought into the premises, and how they might contribute to the spread of fire. In most instances, materials that are capable of rapid surface spread of flame are not permitted in transport facilities. Remedial measures may be necessary to reduce the speed of flame spread. See Part 2, Section 1 for further information.



Figure 6: Fire in a retail unit on a platform (arson) (courtesy of Network Rail)

1.3 Identify sources of oxygen

The main source of oxygen for a fire is in the air around us. In an enclosed building this is provided by the ventilation system in use. This generally falls into one of two categories: natural airflow through doors, windows and other openings; or mechanical air handling/conditioning systems. (The latter is the norm in enclosed or underground facilities.) In many buildings there will be a combination of systems, which will be capable of introducing/extracting air to and from the building.

Additional sources of oxygen can sometimes be found in materials used or stored on the premises, such as:

- some chemicals (oxidising materials), which can provide a fire with additional oxygen and so help it burn. These chemicals should be identified on their container (and Control of Substances Hazardous to Health data sheet, see Figure 7) by the manufacturer or supplier, who can advise as to their safe use and storage;
- oxygen supplies from cylinder storage and piped distribution systems, e.g. oxygen used in welding, cutting, medical services and other operations. Pure oxygen can cause materials, such as grease, to ignite; and
- most pyrotechnics and fireworks, which contain oxidising materials (in gunpowder) and need to be treated with great care. Such materials, e.g. flares used at airports, should be stored in an appropriate manner in a safe area and only be brought to their place of use when required.



Figure 7: Label on oxidising materials



Checklist

- Do you have an emergency plan and, where necessary, have you recorded the details?
- Does your plan take account of other emergency plans applicable in the same building?
- Is the plan readily available for staff to read?
- Is the emergency plan available to the enforcing authority?

STEP 2 IDENTIFY PEOPLE AT RISK

As part of your fire risk assessment, you need to identify those at risk if there is a fire. To do this you need to identify:

- where you have people working, either at permanent locations (e.g. ticket counters, control rooms, departure and arrival gates) or at occasional locations around the premises; and
- who else may be at risk from a fire, e.g. passengers, customers, or other users of the facilities (e.g. visiting contractors and temporary staff) and where these people are likely to be located.

You must consider all the people who use the transport premises, but you should pay particular attention to people who may be especially at risk, such as:

- employees who work alone and/or in isolated areas, e.g. cleaners, security staff;
- people who are unfamiliar with the premises, e.g. new staff, visitors and intermittent use passengers;
- unaccompanied children and young persons;
- people who may have some other reason for not being able to leave the premises quickly, e.g. mobility-impaired or vision-impaired people, people with learning difficulties, elderly customers, people in a state of undress (staff changing rooms), pregnant women or parents with children;
- people with pets and those with a responsibility for animal care, e.g. in quarantine areas of air and sea ports;
- people who are hearing impaired and people whose first language is not English, who might find audible alarms/messages difficult to understand; and
- other people in the immediate vicinity of the premises.

In evaluating the risk to staff with disabilities, you may need to discuss individual needs with them. In premises used extensively by the public, you may need to seek professional advice. The Disability Rights Commission can be a useful source of information.*

Further guidance on people with special needs is given in Part 2, Section 1.

*Visit the Disability Rights Commission website at www.drc-gb.org for more information.



Figure 8: Commuters on a railway platform



Figure 9: A bus station



Checklist

- Have you identified who is at risk?
- Have you identified why they are at risk?
- Have you made a note of your findings?

STEP 3 EVALUATE, REMOVE, REDUCE AND PROTECT FROM RISK

The management of the premises and the way people use it will have an effect on your evaluation of risk. Management may be your responsibility alone or there may be others, such as the building owners or managing agents, who also have responsibilities. In multi-occupancy buildings, all those with some control must co-operate and you need to consider the risk generated by others in the premises.

3.1 Evaluate the risk of a fire occurring

The chances of a fire starting will be low if your premises have few ignition sources and combustible materials are kept away from them.

In general, fires start in one of three ways:

- accidentally, such as when smoking materials are not properly extinguished or when lighting displays are knocked over;
- by act or omission, such as when electrical equipment is not properly maintained or when waste packaging is allowed to accumulate near a heat source, or by storing LPG next to an electric fire or other source of heat; or
- deliberately, such as an arson attack involving setting fire to external rubbish bins placed too close to the building.

Look critically at your premises and try to identify any accidents waiting to happen and any acts or omissions that might allow a fire to start. You should also look for any situation that may present an opportunity for an arsonist.

Further guidance on evaluating the risk of a fire starting is given in Part 2, Section 1.

3.2 Evaluate the risk to people

In Step 2 you identified the people likely to be at risk should a fire start anywhere in the premises and earlier in Step 3 you identified the chances of a fire occurring. It is unlikely that you will have concluded that there is no chance of a fire starting anywhere in your premises, so you now need to evaluate the actual risk to people should a fire start and spread from the various locations you have identified. (In complex premises, you should do this in conjunction with others who may be more familiar with the operation of systems and maintenance procedures.)

To evaluate the risk to people in your premises, you will need to understand the way the fire can spread. Fire is spread by three methods

- convection;
- conduction; and
- radiation.

Convection

Fire spread by convection is the most dangerous and causes the largest number of injuries and deaths. When fires start in enclosed spaces such as buildings, the smoke rising from the fire gets trapped by the ceiling and then spreads in all directions to form an ever-deepening layer over the entire room space. The smoke will pass through any holes or gaps in the walls, ceiling and floor into other parts of the building. The heat from the fire gets trapped in the building and the temperature rises.

In many transport premises, openings in floors may allow smoke and hot gases to move from the fire source to areas occupied by people who may not be immediately aware of the fire, for example smoke from a fire on the sub-surface platform levels spreading through the openings into the upper levels and affecting people on other platforms and the concourse. This lack of containment potentially increases the number of people at risk from a fire.

Conduction

Some materials, e.g. metal shutters, conduits, piping and ducting, can absorb heat and transmit it to an adjacent room, where it can set fire to combustible items that are in contact with the heated material.

Uninsulated doors can transmit a considerable amount of heat and can be hot to the touch on the side remote from the fire.

Radiation

Radiation heats the air in the same way as an electric bar heater heats a room. Any material close to a fire will absorb the heat until the item starts to smoulder and then burn. This may be sufficient to ignite other nearby objects and thus facilitate fire spread.

In most cases, the greatest contributor to the risk to people is whether they are in the open air or in an enclosure where smoke can spread quickly, block exits, and affect people's ability to move when inhaled. When fire occurs, smoke and toxic gases are released.

It is essential that the means of escape and other fire precautions are adequate to ensure that everyone can make their escape to a place of total safety before the fire and its effects can trap them in the building.

In evaluating the risk to people, you will need to consider situations such as:

- fire starting on a lower floor affecting the only escape route for people on upper floors or the only escape route for people with disabilities;
- fire developing in an unoccupied space that people have to pass by to escape from the building;
- fire spreading rapidly through the building because of combustible structural elements and/or large quantities of combustible goods;
- fire or smoke spreading through a building via routes such as vertical shafts, service ducts, ventilation systems, poorly installed, maintained or damaged walls, partitions and ceilings;
- fire and smoke spreading through a building due to poor installation of fire precautions, e.g. incorrectly installed fire doors (see Appendix B for more information on fire doors) or incorrectly installed services penetrating fire walls;
- fire and smoke spreading through the building due to poorly maintained and damaged fire-resisting doors or fire-resisting doors being wedged open;
- fire starting in a service room and affecting hazardous materials (such as flares/detonators or gas cylinders); and
- fire and smoke spreading into the premises from exterior fires, e.g. from road vehicles, locomotives/rolling stock or aircraft.

When considering the effect the fire might have, you may need to take the following points into account:

- In the open air, smoke will rise away from the people present and have a lesser effect on escape than would be the case if the fire were to occur in an enclosed, or partially enclosed, space.
- In an open-sided structure provided with a roof only (e.g. a canopied platform), smoke spread will be similar to that in an enclosed space except that there is likely to be an increased opportunity to escape.
- In other enclosed or partly enclosed structures, e.g. a large railway concourse or airport terminal incorporating upper levels (see Figure 10), the risk to people from the spread of fire and smoke is greater and, therefore, the escape arrangements will need to be designed accordingly.

In a space with a high ceiling the available escape time may be longer.

Further guidance on fire risks is given in Part 2, Section 1.

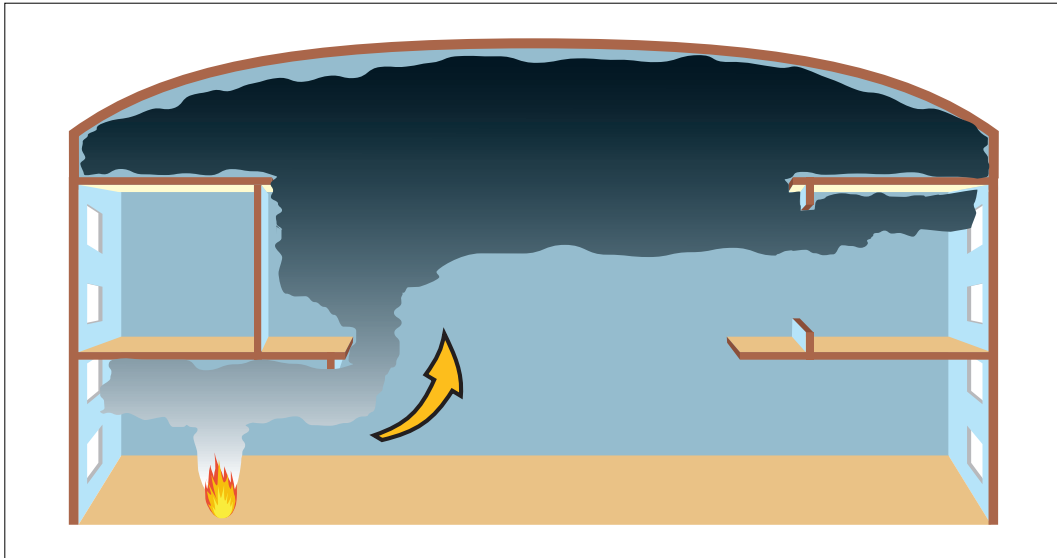

Figure 10: Smoke moving through a building

3.3 Remove or reduce the hazards

Having identified the fire hazards in Step 1, you now need to remove those hazards if reasonably practicable to do so. If you cannot remove the hazards, you need to take reasonable steps to reduce them if you can. This is an essential part of the fire risk assessment and is a priority that must take place before any other actions.

Ensure that any actions you take to remove or reduce the fire hazards or risk are not substituted by other hazards or risks. For example, if you replace a flammable substance with a toxic or corrosive one, you must consider whether this might cause harm to people in other ways.

Remove or reduce sources of ignition

There are various ways that you can reduce the risk caused by potential sources of ignition, for example:

- Replace a potential ignition source with a safer alternative wherever possible.
- Replace naked flame and radiant heaters with fixed convector heaters or a central heating system. Restrict the movement of and guard portable heating appliances.
- Restrict and control the use of naked flames, e.g. candles.
- Operate a safe smoking policy in designated smoking areas, ensuring sufficient ashtrays are provided and cleaned appropriately, and prohibit smoking elsewhere.
- Ensure that sources of heat are kept away from flammable materials such as curtains and displays.
- Ensure that all electrical, mechanical and gas equipment is installed and protected in accordance with the manufacturer's instructions.
- Strictly control all construction work (including alterations) and hot-work processes.
- Ensure that no one carrying out work on gas fittings that involves exposing pipes that contain or have contained flammable gas uses any source of ignition such as blow lamps or hot-air guns.

- Ensure that no one uses any source of ignition while searching for an escape of gas.
- Ensure that all pyrotechnics, fireworks, flares and other hazardous equipment are installed, used, maintained and stored in accordance with the manufacturer's instructions.
- Take precautions to avoid arson.

Remove or reduce sources of fuel

There are various ways in which you can reduce the risks caused by materials and substances that burn, for example:

- Develop a formal system for the control of combustible waste by ensuring that waste materials and rubbish are not allowed to build up and are carefully stored in a secure place, where they pose no hazard to the premises, until properly disposed of.
- Reduce stocks of flammable materials, liquids and gases in public areas to a minimum. Keep the remaining supplies in dedicated storerooms or storage areas (preferably outside) where the public are not allowed to go, and keep the minimum required for the operation of the business.
- Ensure that flammable materials, liquids and gases are kept to a minimum and are stored in an appropriate manner.
- Ensure that all upholstered furniture, curtains, drapes and other soft furnishings are fire retardant, or have been treated with a proprietary fire-retardant treatment designed to enhance their fire performance.
- Remove, cover or treat large areas of highly combustible wall and ceiling linings or insulation (e.g. polystyrene ceiling tiles or carpet tiles) to reduce the rate of flame spread across the surface.
- Ensure that quantities of all pyrotechnics, fireworks, detonators and other hazardous materials are kept to a minimum.
- Take action to avoid any parts of the premises, and in particular storage areas and ground staff equipment, being vulnerable to arson or vandalism.
- Check all areas where hot work (e.g. welding) has been carried out to ensure that no ignition has taken place and no smouldering or hot materials remain that may cause a fire later.

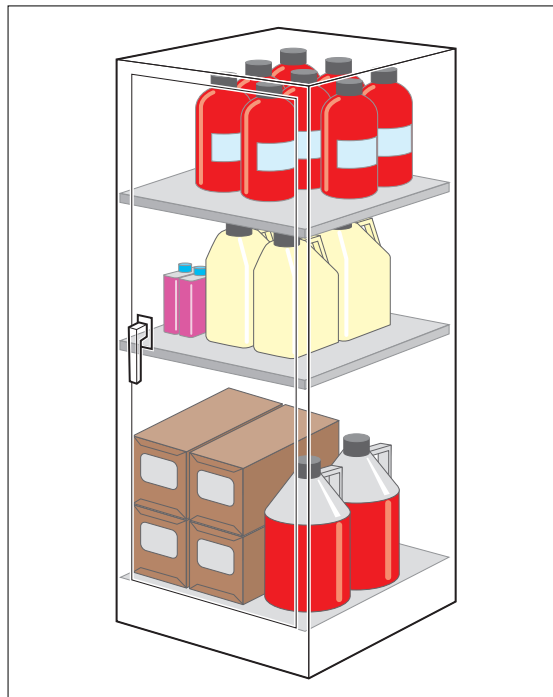

Figure 11: Storage of flammables

Further guidance on removing and reducing hazards is given in Part 2, Section 1.

Remove or reduce sources of oxygen

You can reduce the potential source of oxygen supplied to a fire by:

- closing all doors, windows and other openings not required for ventilation, particularly outside working hours;
- shutting down ventilation systems that are not essential to the function of the premises;
- not storing oxidising materials (including pyrotechnics and fireworks) near or within any heat source or flammable materials;
- controlling the use and storage of oxygen cylinders (e.g. ensuring that they are not leaking and that where they are stored is adequately ventilated); and
- controlling the use and storage of pyrotechnics and fireworks.

3.4 Remove or reduce the risks to people

Having evaluated and addressed the risk of a fire occurring and the risk to people (preventative measures), it is unlikely that you will be able to conclude that no risk remains of a fire starting and presenting a risk to people in your premises.

You now need to reduce the remaining fire risk to a level which is tolerable or as low as reasonably practicable, by ensuring that adequate fire precautions are in place to warn people in the event of a fire and allow them to escape safely.

The rest of this step describes the fire-protection measures you may wish to adopt to reduce the remaining fire risk to people (see Steps 3.4.1 to 3.4.6).

The level of fire protection you need to provide will depend on the level of risk that remains in the premises after you have removed or reduced the hazards and risks. Part 2, Section 4 can help you decide the level of risk that you may still have.

Flexibility of fire-protection measures

Flexibility will be required when applying this guidance: the level of fire protection should be proportional to the fire risk posed to the safety of the people in the premises. Therefore, the objective should be to reduce the remaining risk to a level that is as low as reasonably practicable. The higher the risk of fire and risk to life, the higher the standards of fire protection will need to be.

Your premises may not exactly fit the solutions suggested in this guide and they may need to be applied in a flexible manner without compromising the safety of the occupants.

For example, lengthy means of escape may be mitigated by a combination of control measures such as:

- managed evacuation;
- sprinklers;

- smoke control (SHEVS);
- high ceilings;
- automatic fire detection; and
- compartmentation.

Note: The above list is not exhaustive and is only used to illustrate some examples of trade-offs to provide safe premises.

If you decide to significantly vary away from the benchmarks in this guidance you should seek expert advice before doing so.

3.4.1 Fire-detection and warning systems

In some simple, open-plan, single-storey premises, a fire may be obvious to everyone as soon as it starts. In these cases, where the number and position of exits and the travel distance to them is adequate, a simple shout of 'fire' or a simple manually operated device, such as a gong, whistle or air horn that can be heard by everybody when operated from any single point within the building, may be all that is needed. Where a simple shout or manually operated device is not adequate, it is likely that an electrical fire-warning system will be required.

In most large premises, particularly those with more than one floor, an alarm given from any single point is unlikely to be heard throughout the building. In such circumstances, an electrical system incorporating sounders and manually operated call points (break-glass boxes) is likely to be required. This type of system is likely to be acceptable where all parts of the building are occupied at the same time and it is unlikely that a fire could start without somebody noticing it quickly.

However, in sub-surface railway stations, large railway stations, airport terminals and the like, where there are unoccupied areas (including machine rooms), common corridors and circulation spaces in multi-occupied buildings, or other areas in which a fire could develop to the extent that escape routes could be affected before the fire is discovered, an automatic fire-detection system may be necessary (see Figure 12). In addition, in such premises a voice alarm and public address system (VAPA system) to assist staff and the general public to escape the premises is likely to be needed.

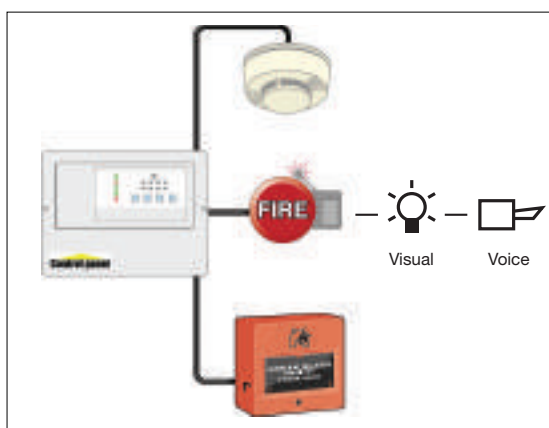

Figure 12: Fire-detection and warning system

You may need to consider special arrangements for times when people are working alone (in hazardous areas), when there are disabled people on the premises, or when your normal occupancy patterns are different, e.g. when maintenance staff or other contractors are working at the weekend.

In the most complex premises, particularly those accommodating large numbers of people (e.g. airports and national rail terminals), it may be appropriate to use phased evacuation, where some areas are evacuated while others are alerted but not evacuated until later. Such evacuation procedures require an integrated alarm system and appropriate staff training.

If you have an alarm system, it is desirable to have an alarm repeater panel at the building entrance and a means of briefing the fire and rescue service when they arrive.

False alarms from electrical fire-warning systems are a major problem and result in many unwanted calls to the fire and rescue service every year. To help reduce the number of false alarms, the design and location of activation devices should be reviewed against the way in which the premises are currently used.

If you are not sure whether your current arrangements are adequate, see the additional guidance on fire-warning systems in Part 2, Section 2.

Checklist



- Can the existing means of detection ensure that a fire is discovered quickly enough for the alarm to be raised in time for all the occupants to escape to a place of total safety?
- Are the detectors of the right type and in the appropriate locations?
- Can the means of warning be clearly heard and understood by everyone throughout the whole building when initiated from a single point? Are there provisions for people in locations where the alarm cannot be heard?
- If the fire-detection and warning system is electrically powered, does it have a back-up power supply?

3.4.2 Firefighting equipment and facilities

Firefighting equipment can reduce the likelihood of a small fire, e.g. in a waste-paper bin, developing into a large one. The safe use of an appropriate fire extinguisher to control a fire in its early stages can reduce the risk to other people in the premises by allowing people to assist others who are at risk.

This equipment will need to comprise enough portable extinguishers and they must be suitable for the risk.

In more complex premises, a number of portable extinguishers may be required (Figure 13) and they should be sited in suitable locations, e.g. on the escape routes at each floor level. It may also be necessary to indicate the location of extinguishers by suitable signs. You should locate extinguishers in areas where they can be easily accessed by trained members of staff, but not in areas open to misuse or vandalism.





Main types of portable extinguishers, their uses and colour coding.			
<p>WATER For wood, paper, textile and solid material fires.</p> 	<p>POWDER For liquid and electrical fires.</p> 	<p>FOAM For use on liquid fires.</p> 	<p>CARBON DIOXIDE (CO₂) For liquid and electrical fires.</p> 
<p>DO NOT USE on liquid, electrical or metal fires</p>	<p>DO NOT USE on metal fires</p>	<p>DO NOT USE on electrical or metal fires</p>	<p>DO NOT USE on metal fires</p>
<p>The contents of an extinguisher are indicated by a zone of colour on the red body. Halon extinguishers are not shown since no new halon production is permitted in the UK.</p>			

Figure 13: Types of fire extinguishers

Some premises will also have permanently installed firefighting equipment such as hose reels, for use by trained staff or firefighters.

People with no training should not be expected to attempt to extinguish a fire. However, all staff should be familiar with the location and basic operating procedures of the equipment provided, in case they need to use it. If your fire strategy requires that certain people, e.g. fire marshals, will be expected to take a more active role, then they should be provided with more comprehensive training.

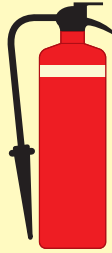
Other fixed installations and facilities to assist firefighters, such as dry rising mains and access for fire engines, or automatically operated, fixed fire suppression systems such as sprinklers and gas or foam flooding systems, may also have been provided.

Where these have been required by law, e.g. the Fire Precautions (Sub-surface Railway Stations) Regulations, the building regulations or local Acts, such equipment and facilities must be properly maintained.

Similarly, if provided for other reasons, e.g. insurance, it is good practice to ensure that they are properly maintained.

In most cases it will be necessary to consult a competent service engineer. Further information is given in Part 2, Section 3. Keeping records of the maintenance carried out will help you demonstrate to the enforcing authority that you have complied with fire safety law.

Appendix A1 provides a sample fire safety maintenance checklist you can use.

For more guidance on portable fire extinguishers see Part 2, Section 3.1, for fixed firefighting installations, Part 2, Section 3.2, and for other facilities (including those for firefighters), Part 2, Section 3.3.

Checklist



- Are the portable fire extinguishers or any fixed firefighting equipment provided suitable for controlling the risks identified?
- Are there enough extinguishers sited throughout the premises at appropriate locations?
- Are the right types of extinguishers located close to the fire hazards and can users get to them without exposing themselves to risk?
- Are the extinguishers visible or does their position need indicating?
- Do you carry out daily checks to ensure that there is clear access for fire engines?
- Are those who test and maintain the equipment competent to do so?
- Do you have the necessary procedures in place to maintain any facilities that have been identified for the safety of people in the building (or for the use of firefighting, such as access for fire engines and firefighting lifts)?

3.4.3 Escape routes

Once a fire has started, been detected and a warning given, everyone in your premises should be able to escape to a place of total safety unaided and without the help of the fire and rescue service. However, some people with disabilities and others with special needs may need help from staff who need to be designated for the purpose.

Escape routes should be designed to ensure, as far as possible, that any person confronted by fire anywhere in the building should be able to turn away from it and escape to a place of reasonable safety, e.g. a protected stairway. From there they will be able to go directly to a place of total safety away from the building.

Those who require special assistance (e.g. very young children and some people with disabilities) could be accommodated on the same level as the final exit from the premises to facilitate escape. Where they need assistance to evacuate, you should make sure that there are sufficient staff to ensure a speedy evacuation.

The level of fire protection that should be given to escape routes will vary depending on the level of risk of fire within the premises and other related factors.

When determining whether your premises have adequate escape routes, you need to consider a number of factors, including:

- the type and number of people using the premises;
- escape time;
- the age and construction of the premises;
- the number and complexity of escape routes and exits;
- the use of phased or delayed alarm evacuation;
- assisted means of escape/personal emergency evacuation plans (PEEPs);
- whether lifts can or need to be used; and
- assembly points.

The type and number of people using the premises

The people present in your premises will sometimes just be employees (out of opening hours) but most of the time will be a mixture of employees and members of the public (including disabled people and unaccompanied children). Employees can reasonably be expected to have an understanding of the layout of the premises, while members of the public, particularly in more complex premises, will be unlikely to have knowledge of alternative escape routes.

The number and capability of people present will influence your assessment of the escape routes. You must ensure that your existing escape routes are sufficient and capable of safely evacuating all the people likely to use your premises at any time, particularly during times of high usage or at peak times. If necessary, you may need to either increase the capacity of the escape routes or restrict the number of people in the premises.

Escape time

In the event of a fire, it is important to evacuate people as quickly as possible from the affected area or the premises. Escape routes in a building should be designed so that people can escape quickly enough to ensure that they are not placed in any danger from fire. The time available for escape will depend on a number of factors, including how quickly the fire is detected and the alarm raised, the number of available escape routes, the nature of the occupants and the speed of fire growth.

The age and construction of the premises

Older buildings may comprise different construction materials from newer buildings, and may be in a poorer state of repair. The materials from which your premises are constructed and the quality of building work and state of repair could contribute to the speed with which any fire may spread, and potentially affect the escape routes the occupants will need to use. A fire starting in a building constructed mainly from combustible material will spread faster than one where fire-resisting construction materials have been used.

If you wish to construct internal partitions or walls in your premises, perhaps to divide up a recreation area, you should ensure that any new partition or wall does not obstruct any escape routes or fire exits, extend travel distances or reduce the sound levels of the fire alarm system. Any walls that affect the means of escape should be constructed of appropriate material. (Further technical information is provided in Appendix B.)

Depending on the findings of your fire risk assessment, it may be necessary to protect the escape routes against fire and smoke by upgrading the construction of the floors, ceilings and walls to a fire-resisting standard. You should avoid having combustible wall and ceiling linings in your escape routes. (For further information see Appendix B.) You may need to seek advice from a competent person. Any structural alterations may require building regulation approval.

The number of escape routes and exits

In general there should usually be at least two escape routes from all parts of the premises, but in some small premises a single escape route may be acceptable from small individual premises within the building (e.g. a premises or part of a premises accommodating fewer than 60 people or where the travel distances are limited).

Where more than one escape route is necessary and to further minimise the risk of people becoming trapped, you should ensure that the escape routes are completely independent of each other. This will prevent a fire affecting more than one escape route at the same time.

When evaluating escape routes, you may need to build in a safety factor by discounting the largest exit from your escape plan or doors that cannot be opened quickly. You can then determine whether the remaining escape routes from a room, floor or building will be sufficient to evacuate all the occupants within a reasonable time. Escape routes that provide escape in a single direction only may need additional fire precautions to be regarded as adequate.

Exit doors on escape routes and final exit doors should normally open in the direction of travel, and be quickly and easily openable without the need for a key. Checks should be made to ensure that final exits are wide enough to accommodate the number and type of people who may use the escape routes they serve.



Figure 14: A blocked corridor and exit with incorrect signage

Management of escape routes

It is essential that escape routes, and the means provided to ensure they are used safely, are managed and maintained to ensure that they remain usable and available at all times when the premises are occupied. Tell employees in staff training sessions about the escape routes within the premises.

Corridors, stairways and other parts of the premises that form part of escape routes should be kept clear and hazard free at all times. Items that may be a source of fuel or pose an ignition risk should never be located on any corridor or stairway that will be used as an escape route.

In complex premises where large numbers of people are in unfamiliar environments, such as sub-surface railway stations and airports, doors on escape routes to non-public areas (e.g. storerooms) should not be openable from the public side other than by authorised personnel.

Further guidance is available in Part 2, Section 4.

Emergency evacuation of persons with mobility impairment

The means of escape you provide must be suitable for the evacuation of everyone likely to be in your premises. This may require additional planning and allocation of staff roles – with appropriate training. Provisions for the emergency evacuation of disabled persons may include:

- stairways;
- evacuation lifts;
- firefighting lifts;
- horizontal evacuation;
- refuges;
- ramps; and
- suitable evacuation equipment.

Use of these facilities will need to be linked to effective management arrangements as part of your emergency plan. The plan should not rely on fire and rescue service involvement for it to be effective.

Further guidance on escape routes is given in Part 2, Section 4.

Making alternative provisions for escape

Traditionally, the means of escape has been based on limiting the travel distances that occupants have to travel to a place of safety. Whilst this approach may be appropriate for other premises, it is not always appropriate for large railway stations (long platforms), underground facilities, airports, ferry terminals (long gates and piers) or tunnels. Many such facilities have escape distances far in excess of distances listed in some guidance documents: this does not mean that such a situation is unsafe. Existing stations can be evaluated on the basis of records of previous evacuations, which may provide an indication of the adequacy of existing means of escape provision.

Alternative approaches can be adopted to satisfy the means of escape provisions, some of which are outlined below:

- hazard management, i.e. reducing the flammable material available to a point where there is little to burn (this is a common approach used in sub-surface stations);
- aligning escape routes to reflect general circulation routes as occupants will generally use routes they are familiar with (learned irrelevance);
- the use of escalators under management control is a very effective method of moving a large number of occupants to a place of relative safety. In emergency conditions, escalators may be reversed in order to increase the available capacity for the means of escape;
- providing escape routes that are remote from each other to avoid them being rendered impassable by a single incident;
- providing artificial illumination of the paths of travel to aid way-finding and reduce evacuation time. Typically, emergency escape lighting is provided through battery or other supplies, such as generators, which are activated on failure of the normal supply;
- stairs designed in accordance with the building regulations provide easily negotiated inclines and are intended to minimise trips and falls on the stairs and have sufficient landings to avoid multiple falls;
- where escape stairs have the potential to be affected by smoke and/or hot gases from the fire, they could be pressurised or protected by lobbies to ensure their availability in an emergency; and
- providing fire and smoke control facilities (e.g. sprinklers) to increase the time available for escape.

In assessing the adequacy of alternative approaches, it is likely that you will need to seek advice from a competent person.

The adequacy of the means of escape provision can be improved by controlling the occupant load. This may require imposing limits on the numbers of persons through licence restrictions and/or through operational controls (e.g. crowd management).

Further guidance is available in Part 2, Section 4.



Checklist

- Is your building constructed, particularly in the case of multi-storey buildings, so that, if there is a fire, heat and smoke will not spread uncontrolled through the building to the extent that people are unable to use the escape routes?
- Are any holes or gaps in walls, ceilings and floors properly sealed, e.g. where services such as ventilation ducts and electrical cables pass through them?
- Can all the occupants escape to a place of total safety in a reasonable time?
- Are the existing escape routes adequate for the numbers and type of people that may need to use them, e.g. staff, contractors, members of the public and disabled people?
- Are the exits in the right place and do the escape routes lead as directly as possible to a place of total safety?
- If there is a fire, could all available exits be affected or will at least one route from any part of the premises remain available?
- Are the escape routes and final exits kept clear at all times?
- Do the doors on escape routes open in the direction of escape?
- Can all final exit doors be opened easily and immediately if there is an emergency?
- Will everybody be able to safely use the escape routes from your premises? Are all escape routes in the building properly maintained and available for use when required?
- Are the people who work in the building aware of the importance of maintaining the safety of the escape routes, e.g. by ensuring that fire doors are not wedged open and that combustible materials are not stored within escape routes?
- Are there any particular or unusual issues to consider?

3.4.4 Emergency escape lighting

People in your premises must be able to find their way to a place of total safety if there is a fire by using escape routes that have enough lighting. Where any escape routes are internal and without windows (e.g. sub-surface railway stations and subways), or your premises are used during periods of darkness, then some form of back-up to the normal escape route lighting (emergency escape lighting) is likely to be required.

In simple premises (e.g. small rail and bus stations) where the escape routes are straightforward, borrowed lighting, e.g. from street lamps where they illuminate escape routes, may be acceptable. Where borrowed lighting is not available, suitably placed torches may be acceptable for the use of staff only.

Where people have difficulty seeing conventional signs, a 'way-guidance' system may need to be considered.

Further guidance on emergency escape lighting is given in Part 2, Section 5.

Checklist



- Are all your escape routes covered by an acceptable form of emergency lighting?
- Are your premises used during periods of darkness?
- Will there always be sufficient lighting to use escape routes safely?
- Do you have back-up power supplies for your emergency lighting?

3.4.5 Signs and notices

Signs

Signs must be used, where necessary, to help people identify escape routes and find firefighting equipment and emergency fire telephones. These signs are required under the Health and Safety (Safety Signs and Signals) Regulations 1996¹³ and must comply with the provisions of those regulations.

A fire risk assessment that determines that no escape signs are required (because, for example, trained staff will always be available to help visitors to escape routes) is unlikely to be acceptable to an enforcing authority.

For a sign to comply with these regulations it must be in pictogram form (see Figure 15). The pictogram can be supplemented by text if this is considered necessary to make the sign more easily understood, but you must not have a safety sign that uses only text.



Figure 15: Typical fire exit sign

Where the locations of escape routes and firefighting equipment are readily apparent and the firefighting equipment is visible at all times, then signs are not necessary. In all other situations it is likely that the fire risk assessment will indicate that signs will be necessary.

Notices

Notices must be used, where necessary, to provide the following:

- instructions on how to use any fire safety equipment;
- the actions to be taken in the event of fire; and
- help for the fire and rescue service (e.g. location of sprinkler valves or electrical cut-off switches).

All signs and notices should be positioned so that they can be easily seen and understood (Figure 16).

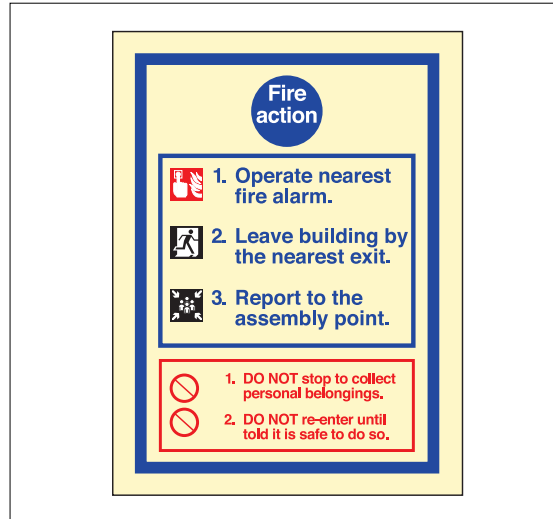

Figure 16: Simple fire action notice

Further guidance on signs and notices is given in Part 2, Section 6.

Checklist



- Where necessary, are escape routes and exits, the locations of firefighting equipment and emergency fire telephones indicated by appropriate signs?
- Have you provided notices such as those giving information on how to operate security devices on exit doors, those indicating doors enclosing fire hazards that must be kept shut and fire action notices for staff and other people?
- Are you maintaining all the necessary signs and notices so that they continue to be correct, legible and understood?
- Are you maintaining signs that you have provided for the information of the fire and rescue service, such as those indicating the location of water suppression stop valves and the storage of hazardous substances?

3.4.6 Installation, testing and maintenance

New fire precautions should be installed by a competent person.

You must ensure that any existing fire safety equipment, devices or facilities that are provided in your premises for the safety of people, such as fire alarms, fire extinguishers, lighting, signs, fire exits and fire doors, are in effective working order and maintain fire separating elements designed to prevent fire and smoke entering escape routes.

You must ensure that regular checks, periodic servicing and maintenance are carried out whatever the size of your premises. Any defects should be put right as quickly as possible.

You, or a competent person you have appointed, can carry out certain checks and routine maintenance work. Further maintenance may need to be carried out by a competent service engineer. Where contractors are used, third party certification is one method whereby a reasonable assurance of the quality of work and competence can be achieved (see Part 2, Section 8).

The following are examples of checks and tests that should be considered. The examples of testing and maintenance given are not intended to be prescriptive and other testing regimes may be appropriate.

Daily checks

Remove bolts, padlocks and security devices from fire exits. Ensure that doors on escape routes swing freely and close fully. Check escape routes to ensure they are clear from obstructions and combustible materials and are in a good state of repair. Open all final exit doors to the full extent and walk exterior escape routes. Check the fire alarm panel to ensure the system is active and fully operational. Where practicable, visually check that emergency escape lighting units are in good repair and are working. Check that all safety signs and notices are legible. (See Appendix B3 for more details on bolts, padlocks and security devices.)

Weekly tests and checks

Test fire-detection and warning systems and manually operated warning devices following the manufacturer's or installer's instructions. Carry out smoke control and sprinkler tests. Fire pumps and standby diesel engines should be tested for 30 minutes each week. Check the batteries of safety torches and that fire extinguishers and hose reels are correctly located and in apparent working order.

Monthly tests and checks

Test all emergency escape lighting systems and safety torches to make sure they have enough charge and illumination according to the manufacturer's or supplier's instructions or relevant standards. This should be at an appropriate time when, following the test, they will not be required immediately.

Check that all fire doors are in good working order and closing correctly and that the door frames and seals are intact.

Six-monthly tests and checks

A competent person should test and maintain the fire-detection and warning system.

Annual tests and checks

The emergency escape lighting and all firefighting equipment, fire alarms and other installed sprinkler and smoke control systems should be tested and maintained by a competent person.

All structural fire protection and elements of fire compartmentation should be inspected and any remedial action carried out. Specific guidance on the maintenance of timber fire-resisting doors is given in Appendix B2.

Appendix A1 provides an example of a fire safety maintenance checklist. You will find it of benefit to keep a log book of all maintenance and testing.

Further guidance on maintenance and testing of individual types of equipment and facilities can be found in the relevant sections in Part 2.

Checklist



- Do you regularly check all fire doors and escape routes and associated lighting and signs?
- Do you regularly check all your firefighting equipment?
- Do you regularly check your fire-detection and alarm equipment?
- Are those who test and maintain the equipment competent to do so?
- Do you keep a log book to record tests and maintenance?

Step 3 Checklist



Evaluate, remove, reduce and protect from risks by:

- Evaluating the risk to people in your premises if a fire starts.
 - Removing or reducing the hazards that might cause a fire.
- Have you:
- Removed or reduced sources of ignition?
 - Removed or reduced sources of fuel?
 - Removed or reduced sources of air or oxygen?
- Have you removed or reduced the risks to people if a fire occurs by:
- Considering the need for fire detection and for warning?
 - Considering the need for firefighting equipment?
 - Determining whether your escape routes are adequate?
 - Determining whether your lighting and emergency lighting are adequate?
 - Checking that you have adequate signs and notices?
 - Regularly testing and maintaining safety equipment?
 - Considering whether you need any other equipment or facilities?

STEP 4 RECORD, PLAN, INFORM, INSTRUCT AND TRAIN

In Step 4 there are four further elements of the risk assessment you should focus on to address the management of fire safety in your premises. In some premises with simple layouts this could be done as part of the day-to-day management; however, as the premises or the organisation get larger it may be necessary for a formal structure and written policy to be developed. Further guidance on managing fire safety is given in Part 2 on page 47.

4.1 Record the significant findings and action taken

If you or your organisation employs five or more people, your premises are licensed, or an alterations notice requiring you to do so is in force, you must record the significant findings of your fire risk assessment and the actions you have taken.

Significant findings should include details of:

- the fire hazards you have identified (you don't need to include trivial things like a small tin of solvent-based glue);
- the actions you have taken or will take to remove or reduce the chance of a fire occurring (preventative measures);
- persons who may be at risk, particularly those especially at risk;
- the actions you have taken or will take to reduce the risk to people from the spread of fire and smoke (protective measures);
- the actions people need to take in case of fire, including details of any persons nominated to carry out a particular function (your emergency plan); and
- the information, instruction and training you have identified that people need and how and to whom it has been and will be given.

For further information, see Part 2.

You may also wish to record discussions you have had with staff or staff representatives (including trade unions).

Even where you are not required to record the significant findings, it is good practice to do so.

In some simple premises, record keeping may be no more than a few sheets of paper (possibly forming part of a health and safety folder), containing details of significant findings, any action taken and a copy of the emergency plan.

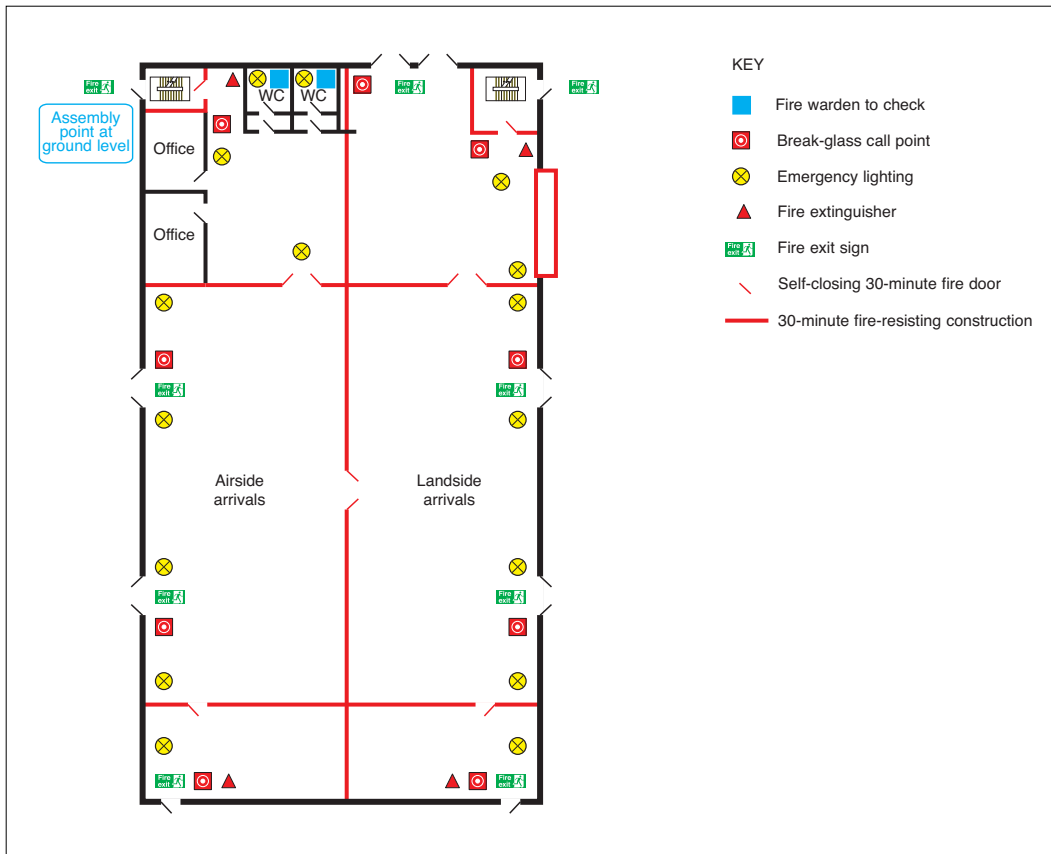

Figure 17: Example of a line drawing showing general fire safety precautions

The record could take the form of a simple list, which may be supported by a simple plan of the premises (see Figure 17).

In more complex premises, it is best to keep a dedicated record including details of significant findings, any action taken, a copy of the emergency plan, maintenance of fire-protection equipment and training. There is no one 'correct' format specified for this. Further guidance is given in Part 2, Section 7.1.

You must be able to satisfy the enforcing authority, if called upon to do so, that you have carried out a suitable and sufficient fire risk assessment. Keeping records will help you do this and will also form the basis of your subsequent reviews. If you keep records, you do not need to record all the details, only those that are significant and the action you have taken.

The findings of your fire risk assessment will help you to develop your emergency plan, identify the instruction, information and training you need to provide, identify the co-operation and co-ordination arrangements you may need to have with other responsible people, and identify the arrangements for maintenance and testing of the fire precautions. If you have identified any significant findings that require additional fire-protection measures, you need to develop an action plan.

Further guidance about safety records with examples is given in Part 2, Section 7.1.



Checklist

- Have you recorded the significant findings of your assessment?
- Have you recorded what you have done to remove or reduce the risk?
- Are your records available for inspection by the enforcing authority?

4.2 Emergency plans

You need to have an emergency plan for dealing with any fire situation.

The purpose of an emergency plan is to ensure that the people in your premises know what to do if there is a fire and that the premises can be evacuated safely.

If you or your organisation employs five or more people, or your premises are licensed or an alterations notice requiring it is in force, then details of your emergency plan must be recorded. Even if it is not required, it is good practice to keep a record.

Your emergency plan should be based on the outcome of your fire risk assessment and be available for your employees, their representatives (where appointed) and the enforcing authority.

In some premises with simple layouts the emergency plan may be no more than a fire action notice.

In multi-occupied and more complex transport premises (particularly multi-mode interchanges), the emergency plan will need to be more detailed and compiled only after consultation with staff members or their representatives, other occupiers and other responsible people (e.g. owners and/or managers) within the premises and, where necessary, the emergency services. In most cases this means that a single emergency plan covering the whole premises will be necessary. It will help if you can agree on one person to co-ordinate this task.

You must consider what reasonable adjustments might be needed for blind or visually impaired people as many do not read Braille, e.g. pictorial explanations, information provided on tape or broadcast live on a PA system.

Further guidance on emergency plans is given in Part 2, Section 7.2.



Checklist

- Do you have an emergency plan and, where necessary, have you recorded the details?
- Does your plan take account of other emergency plans applicable in the building?
- Is the plan readily available for staff to read?
- Is the emergency plan available to the enforcing authority?

4.3 Inform, instruct, co-operate and co-ordinate

You must give clear and relevant information and appropriate instructions to your staff and the employers of other people working in your premises, such as contractors, about how to prevent fires and what they should do if there is a fire.

Any other relevant persons should be given information about the fire safety arrangements as soon as possible, e.g. contractors when they start work.

Information and instruction

All staff should be given information and instructions as soon as possible after they are appointed and regularly after that. Make sure you include staff who work outside normal working hours, such as contract cleaners or maintenance staff.

The information and instructions you give must be in a form that can be used and understood. They should take account of those with a disability (e.g. hearing or sight impairment), those with learning difficulties and those who do not use English as their first language.

The information and instructions you give should be based on your emergency plan and must include:

- the significant findings from your fire risk assessment;
- the measures that you have put in place to reduce the risk;
- what staff should do if there is a fire;
- the identity of people you have nominated with responsibilities for fire safety; and
- any special arrangements for serious and imminent danger to persons from fire.

In simple premises, where no significant risks have been identified and there are limited numbers of staff and the public, information and instruction may simply involve an explanation of the fire procedures and how they are to be applied. This should include showing staff the fire-protection arrangements, including the designated escape routes, the location and operation of the fire-warning system and any other fire-safety equipment provided (e.g. fire extinguishers). Fire action notices can complement this information and, where used, should be posted in prominent locations.

In complex premises, particularly those in large, multi-storey buildings, you should ensure that written instructions are given to people who have been nominated to carry out a designated safety task, such as calling the fire and rescue service or checking that exit doors are available for use at the start of each working day.

Further guidance on information and instruction to staff is given in Part 2, Section 7.3.

Co-operation and co-ordination

In some premises (e.g. owner-occupied premises) you may be solely responsible for all parts of the building. However, in premises owned by someone else or where there is more than one occupier and others are responsible for different parts of the premises, it is important that you liaise with them and inform them of any significant risks that you have identified. By liaising you can co-ordinate your resources to ensure that your actions and working practices do not place others at risk if there is a fire, and that a co-ordinated emergency plan operates effectively.

Where two or more responsible persons share premises in which an explosive atmosphere may occur, the responsible person with overall responsibility for the premises must co-ordinate any measures necessary to protect everyone from any risk that may arise. Employees also have a responsibility to co-operate with their employer so far as it is necessary to help the employer comply with any legal duty.

Further guidance on co-operation and co-ordination is given in Part 2, Section 7.3.

Checklist



- Have you told your staff about the emergency plan, including the identity of people you have nominated to do a particular task?
- Have you given staff information about any dangerous substances?
- Do you have arrangements for informing temporary or agency staff?
- Do you have arrangements for informing other employers whose staff are guest workers in your premises, such as maintenance contractors and cleaners?
- Have you informed guests and visitors about what to do in an emergency?
- Have you co-ordinated your fire safety arrangements with other responsible people in the premises?
- Have you recorded details of any information or instructions you have given and the details of any arrangements for co-operation and co-ordination with others?

4.4 Fire safety training

You must provide adequate fire safety training for your staff. The type of training should be based on the particular features of your premises and should:

- take account of the findings of the fire risk assessment;
- explain your emergency procedures;
- take account of the work activity and explain the duties and responsibilities of staff;
- take place during working hours and be repeated periodically where appropriate;

- be easily understandable by your staff and other people who may be present; and
- be tested by fire drills.

In simple premises this may be no more than showing new staff the fire exits and giving basic training on what to do if there is a fire. In most premises with a high staff turnover (and/or many shift patterns) and high passenger throughput, the organisation of fire safety training will need to be more formal, e.g. by an induction course. Some of your staff may have received some fire safety training as part of a national accreditation scheme. Guidance may be sought from relevant documents, for example the guidance for existing British Rail surface stations.¹⁴

Your staff training should include the following:

- an overview of the facilities and the fire safety measures;
- what to do on discovering a fire;
- how to raise the alarm and what happens then;
- what to do upon hearing the fire alarm;
- the procedures for alerting members of the public and visitors including, where appropriate, directing them to exits;
- the arrangements for calling the fire and rescue service;
- the evacuation procedures for everyone (including the public and contractors) in your premises to reach an assembly point at a place of total safety;
- the location and, when appropriate, the use of firefighting equipment;
- the location of escape routes, especially those not in regular use;
- the importance of keeping fire-resisting doors closed to prevent the spread of fire, heat and smoke;
- where appropriate, how to stop machines and processes and isolate power supplies in the event of a fire;
- the reason for not using lifts (except those specifically installed or nominated, following a suitable fire risk assessment);
- the safe use of and risks from storing or working with highly flammable and explosive substances; and
- the importance of general fire safety, which includes good housekeeping.

All the employees identified in your emergency plan who have a supervisory role if there is a fire (e.g. heads of departments, fire marshals or wardens and, in more complex premises, fire parties or teams), should be given details of your fire risk assessment and receive additional training.

Further guidance on training and how to carry out a fire drill is given in Part 2, Section 7.4.



Checklist

- Have your staff received any fire safety training?
- Have you carried out a fire drill recently?
- Are employees aware of specific tasks if there is a fire?
- Are you maintaining a record of training sessions?
- Do you carry out joint training and fire drills in multi-occupied buildings?
- If you use or store hazardous or explosive substances, have your staff received appropriate training?

STEP 5 REVIEW

You should constantly monitor what you are doing to implement the fire risk assessment and to assess how effectively the risk is being controlled.

If you have any reason to suspect that your fire risk assessment is no longer valid or there has been a significant change in your premises that has affected your fire precautions, you will need to review your assessment and, if necessary, revise it. Reasons for review could include:

- changes to work processes or the way that you organise them, including the introduction of new equipment;
- introduction of or changes to temporary exhibitions or stands;
- alterations to the premises, including the internal layout;
- significant changes to furniture and fixings;
- the introduction, change of use or increase in the storage of hazardous substances;
- the failure of fire precautions, e.g. fire-detection systems and alarm systems, fire suppression systems or smoke control systems (SHEVS);
- significant changes to displays or quantities of stock;
- a significant increase in the number of people present; and
- changes to the level of accessibility for people with some form of disability.

You should consider the potential risk of any significant change before it is introduced.

Do not amend your assessment for every trivial change, but if a change introduces new hazards, you should consider them and, if significant, do whatever you need to do to keep the risks under control. In any case you should keep your fire risk assessment and emergency plan under review in order to make sure that the precautions are still working effectively. You may want to re-examine the fire prevention and protection measures at the same time as your health and safety assessment. As with the original risk assessment, consultation should take place with employees or their elected representatives.

If a fire or 'near miss' occurs, this could indicate that your existing assessment may be inadequate and you should carry out a reassessment. It is good practice to identify the cause of any incident and then review and, if necessary, revise your fire risk assessment in the light of this.

Records of testing, maintenance and training are useful aids in a review process. See Appendix A1 for an example.

Alterations notices

If you have been served with an alterations notice, check it to see whether you need to notify the enforcing authority about any changes you propose to make as a result of your review. If these changes include building work, you should also consult a building control body. (Note that some facilities are exempt from building control and make their own arrangements to meet the intent or the requirements as they apply to their transport premises and operations.)

END OF PART 1

You should now have completed the five-step fire risk assessment process, using the additional information in Part 2 where necessary. In any review you may need to revisit Steps 1 to 4.

Part 2 Further guidance on fire risk assessment and fire precautions

Managing fire safety

Good management of fire safety in your premises or facility is essential to ensure that any fire safety matters that arise are always addressed effectively. In simple transport organisations this can be achieved by the responsible person maintaining and planning fire safety in conjunction with general health and safety. BS 5588-12¹⁵ and the HSE (HSG65)⁹ provide further guidance on safety management.

In larger organisations it is good practice for a senior manager to be appointed by the responsible person as a competent person who have overall responsibility for fire safety. It may be appropriate for this responsibility to be placed with the manager designated with overall responsibility for health and safety.

An organisation's fire safety policy should be flexible enough to allow modification. This fire safety policy could be a part of the organisations general health and safety policy. This is particularly important when local managers have to function daily with other businesses in the same building. It should be recognised that fire safety operates at all levels within an organisation and therefore local managers should be able to develop, where necessary, a local action plan for their premises.

The organisation's policy should be set out in writing and may cover such things as:

- who will hold the responsibility for fire safety at board level;
- who will be the responsible person for each of their premises (this will be the person who has overall control, usually the manager, but may be part-time or shift managers);
- the arrangement whereby managers will, where necessary, nominate in writing specific people to carry out particular tasks if there is a fire; and
- the arrangement whereby regional or area managers should monitor and check that individual managers are meeting the requirements of the fire safety law.

You should have a plan of action to bring together all the features you have evaluated and noted from your fire risk assessment so that you can plan what needs to be done. It should not be confused with the emergency plan, which is a statement of what you will do if there is a fire.

The plan of action should include what you intend to do to reduce the hazards and risks you have identified and to implement the necessary protection measures.

You will need to prioritise these actions to ensure that any findings which identify people in immediate danger are dealt with straight away, e.g. ensuring that fire exits are not locked. In other cases where people are not in immediate danger but action is still necessary, it may be acceptable to plan this over a period of time.

Depending on the finding of the risk assessment, in complex premises, for example sub-surface railway stations, you (or a designated manager) should be in charge of and be present on the premises the whole time that the premises are open to the public, and should be available for general fire safety management as identified under the fire risk assessment and emergency plan.

Before admitting the public to your premises you need to ensure that all of your fire safety provisions are in place and in working order.

It is important that the manager ensures that where, for operational reasons, staff are transferred to another part of the premises, they are made aware of the means of escape and fire procedures of the new work area (including any additional responsibilities) if this differs from their permanent duty station.

Where your premises or parts of your premises are either hired or leased then the management responsibilities of the hirer should be defined.

Information for the day manager

Where the person responsible for the day-to-day management of the premises, e.g. the station manager or operations manager, undertakes the ongoing implementation, review and revision of the risk assessment, this may not necessarily be the person who carried out the risk assessment, so you must inform them of their roles and responsibilities. This person is responsible for ensuring that:

- escape doors and routes are kept clear and available at all times;
- fire doors are kept shut;
- holes in fire resisting construction are rectified;
- essential power supplies are permanently available;
- temporary or permanent alterations to the premises are monitored and managed;
- the interface with new and existing tenants and the provision of information on all relevant fire safety issues, e.g. fire escapes and procedures, fire systems and relevant key issues from the risk assessment, are maintained;
- good housekeeping practices are maintained; and
- guidance is provided to local staff and feedback to the organisation on developing and updating the emergency plan.

This list is not exhaustive and should be developed to suit your premises.

The guidance in Part 2 provides additional information to:

- ensure good fire safety management by helping you establish your fire prevention measures, fire precautions and fire safety procedures (systems, equipment and plans); and
- assist you to carry out your fire safety risk assessment and identify any issues that need attention.

Figure 18: Station fire (courtesy of Network Rail)



Figure 19: Fire in an air-handling unit (electrical) (courtesy of Network Rail)



Section 1 Further guidance on fire risks and preventative measures

This section provides further information on evaluating the risk from a fire and its prevention in your premises. You should spend time developing long-term workable and effective strategies to reduce hazards and the risk of a fire starting. At its simplest this means separating flammable materials from ignition sources.

You should consider:

- housekeeping;
- storage;
- dangerous substances: storage and use;
- equipment and machinery;
- electrical safety;
- smoking;
- managing building work and alterations;
- escape routes;
- restricting the spread of fire and smoke;
- fire-resisting structures;
- arson; and
- help for people with special needs.

1.1 Housekeeping

Good housekeeping will lower the chances of a fire starting, so the accumulation of combustible materials in premises should be monitored carefully. Good housekeeping is essential to reduce the chances of escape routes and fire doors being blocked or obstructed.

Figure 20: Bins under a stairway (courtesy of Cheshire fire and rescue service)



Refuse

The accumulation of waste and litter likely to be generated by high volumes of passengers (such as newspapers and food and drink packaging) should be avoided. All parts of the premises should therefore be inspected periodically (hourly or daily) depending on the degree of access by the public. Any accumulation of waste or litter should be removed without delay or kept in a fire-resisting container or room, pending removal.

Sufficient waste and litter bins should be provided and arrangements made for their frequent emptying.

Waste material should be kept in suitable containers prior to removal from the premises. If waste containers (particularly wheeled bins) are sited outside the premises:

- they should be secured in a compound to prevent them being moved to a position next to the premises and set on fire; and
- they should never be placed against a building or vehicle (Figure 20) and should normally be a minimum of 6m away from any part of the premises.

If you generate a considerable quantity of combustible waste material, you may need to develop a formal plan to manage this effectively.

1.2 Storage

Many of the materials found in your premises will be combustible. If your premises have inadequate or poorly managed storage areas, then the risk of fire is likely to be increased (see Figure 21). The more combustible materials you store the greater the source of fuel for a fire. Poorly arranged storage could prevent equipment such as sprinklers working effectively.

Combustible materials are not just those generally regarded as highly combustible, such as polystyrene, but all materials that will readily catch fire.

Stacks of combustible materials (e.g. waste material) can increase the fire hazard. Such readily available combustible material makes the potential effect of arson more serious.

Combustible materials stacked adjacent to electrical equipment or heaters increase the fire hazard and should be avoided.

Figure 21: An example of poor storage



Careful consideration of the type of material, the quantities kept and the storage arrangements can lead to significant reductions in both the fire hazard and the associated risk.

Your fire risk assessment should also consider any additional risk generated by seasonal products such as promotional material and Christmas decorations.

Consider the following to reduce these risks:

- ensure that electrical lighting used as part of the display does not become a potential source of ignition;
- ensure that storage and display areas are adequately controlled and monitored;
- do not store excess materials in display areas; and
- use fire-retardant display materials wherever possible (suppliers should be able to supply evidence of this).

1.3 Dangerous substances: storage, display and use

Specific precautions are required when handling and storing dangerous substances to minimise the possibility of an incident. Your supplier should be able to provide detailed advice on safe storage and handling; however, the following general principles will help you reduce the risk from fire:

- substitute highly flammable substances and materials with less combustible ones;
- reduce the quantity of dangerous substances to the smallest reasonable amount necessary for the operation of the business or organisation;
- store dangerous substances correctly, e.g. in a fire-resisting enclosure. Ideally, all flammable liquids and gases should be secured, especially when the premises are unoccupied, to reduce the chance of them being used in an arson attack; and
- ensure that you and your employees are aware of the fire risk the dangerous substances present and the precautions necessary to avoid danger.

Additional general fire precautions may be needed to take account of the additional risks that may be posed by the storage and use of these substances.

Certain substances and materials are by their nature highly flammable, oxidising or potentially explosive. These substances are controlled by other legislation in addition to fire safety law, in particular the Dangerous Substances and Explosive Atmospheres Regulations 2002¹⁶ (see also the HSE's *Approved code of practice and guidance*¹⁷).

Flammable liquids

Highly flammable liquids present a particularly high fire risk.

The risk is reduced by ensuring that the storage and use of highly flammable liquids is carefully managed, that materials contaminated with solvent are properly disposed of (see Figure 23) and, when not in use, they are safety stored. Up to 50 litres may be stored in a fire-resisting cabinet or bin that will contain any leaks (see Figure 22).

Figure 22: A 50-litre flammable storage bin

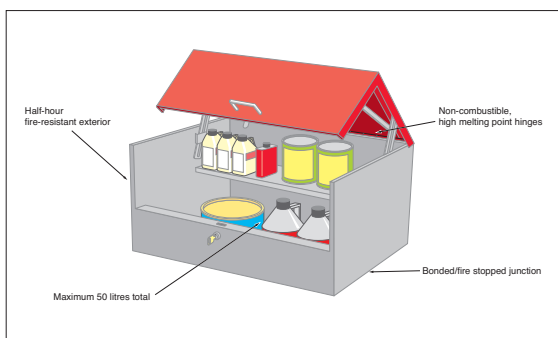

There should be no potential ignition sources in areas where flammable liquids are used or stored and flammable concentrations of vapours or dusts may be present. Any electrical equipment used in these areas, including the fire alarm and emergency lighting systems, needs to be suitable for use in flammable atmospheres. In such situations, it is recommended that you seek advice from a competent person.

Figure 23: A fire-resisting pedal bin for rags



Fuel tanks containing flammable or combustible liquids should be properly designed for the purpose. Tanks are generally safer outdoors, where vapours will not accumulate and the tanks can be accessed in the event of fire. Above-ground tanks are more likely to explode, due to fire around the tank. Overheating and emergency relief vents or other measures should be considered, to prevent the explosive failure of tanks. Tanks in basements should generally be limited in size and, where possible, contained within a room which will prevent the fire from spreading to other areas.

LPG storage and use

Where LPG in cylinders or cartridges is present, you need to take particular care to minimise the possibility of its involvement in a fire. The total amount of LPG should be kept to the minimum necessary to meet your needs. Keep LPG cylinders, both full and empty, separate from other flammable materials, in a safe and secure location, either in the open air or in a properly constructed and adequately ventilated storeroom.

Bulk storage tanks and bulk cylinder stores should be designed, installed and located in accordance with industry guidance.

Further guidance on the safe storage of LPG is available from your supplier or the Liquefied Petroleum Gas Association's Code of Practice.⁸⁷

Hazardous materials

Where it is necessary to use hazardous materials, such as fuels (whether in containers or within fuel tanks and machinery), fertilisers, weed killers or paints, they should be stored in a secure and safe location, for example a properly ventilated fire-resistant storeroom. Care should also be taken to ensure that incompatible materials are not stored together. If in any doubt you should seek the advice of your supplier.

Explosive and flammable substances

Explosives and flammable substances may be present in some transportation premises, for example:

- flares (airports);
- fireworks (confiscated from passengers travelling through transport premises employing security screening);
- detonators (railways); and
- dangerous goods transportation.

These have the potential for a violent release of pressure and heat that can cause severe harm to people and damage to a building.

You should adopt and enforce a clear policy to either prohibit or manage any explosives or flammable substances that may enter the premises.

Where fireworks and explosives are stored, a licence will be required under the Manufacture and Storage of Explosives Regulations 2005.¹⁹ Further guidance is available on the HSE website at www.hse.gov.uk/explosives and in an HSE leaflet.²⁰

Piping

Piping conveying gas or flammable liquid should, as far as practical, be constructed from a rigid metal. Any necessary flexible piping should be constructed of material suitable for the gas or liquid being transported; it should be adequately reinforced to resist crushing and withstand the maximum internal pressure to which it may be subjected. Any connections to the flexible piping should be of an approved pattern (i.e. screwed or otherwise secured to prevent accidental disconnection). If in doubt you should seek advice from a competent person.

External areas

A fire risk problem that is often found around transport premises is the natural undergrowth that may grow right up to the premises. This offers a target for arsonists and is a source of accidental fires. It is important that undergrowth is regularly trimmed right back and the ground treated to prevent a reoccurrence. If using weed killers, care should be taken to avoid using those which leave a flammable residue.

1.4 Equipment and machinery

Common causes of fire in equipment and machinery are:

- allowing ventilation points to become clogged or blocked, causing overheating;
- allowing extraction equipment in catering environments to build up excessive grease deposits;
- loose drive belts or lack of lubrication leading to increased friction;
- disabling or interfering with automatic or manual safety features and cut-outs;
- leaking valves, glands or joints allowing oils and other flammable liquids to contaminate adjacent floors or goods; and
- misuse or lack of maintenance of cooking equipment and appliances.

All machinery, equipment and plant should be suitable for its application, be installed (and protected) in accordance with both the manufacturer's instructions and the appropriate standard, and be properly maintained by a competent person. Appropriate signs and instructions on safe use of the equipment may be necessary.

Heating

Individual heating appliances require care if they are to be used safely, particularly those which are kept for emergency use during a power cut or as supplementary heating during severe weather. The greatest risks arise from a lack of maintenance and user unfamiliarity with them. Heaters should be secured in position when in use and fitted with a fire guard if appropriate.

As a general rule, convector or fan heaters should be preferred to radiant heaters because they present a lower risk of fire and injury.

The following rules should be observed:

- All heaters should be kept well clear of combustible materials and where they do not cause an obstruction.
- Heaters which burn a fuel should be sited away from draughts and any potential flammable vapours.
- Portable fuel burning heaters (including LPG and bottled gas powered heaters) should only be used in public areas in exceptional circumstances and if shown to be acceptable in your risk assessment.

All gas heating appliances should be used only in accordance with the manufacturer's instructions and should be serviced annually by a competent person.

1.5 Electrical safety

Electrical equipment is a significant cause of accidental fires in premises. The main causes are:

- overheating cables and equipment, e.g. due to overloading circuits;
- incorrect installation or use of equipment;
- lack of maintenance or testing of equipment;
- incorrect fuse rating;
- damaged or inadequate insulation on cables or wiring;

- combustible materials being placed too close to electrical equipment which may give off heat even when operating normally or may become hot due to a fault;
- arcing or sparking by electrical equipment; and
- embrittlement and cracking of cable sheathing in cold environments.

All electrical equipment should be installed and maintained in a safe manner by a competent person. If portable electrical equipment is used, including items brought into a workplace by employees, then your fire risk assessment should ensure that it is visually inspected and undergoes portable appliance testing ('PAT') at intervals suitable for the type of equipment and its frequency of use (refer to the HSE guidance *Maintaining portable and transportable electrical equipment* (HSG107)²²). If you have any doubt about the safety of your electrical installation then you should consult a competent electrician.

Issues to consider include:

- overloading of equipment;
- correct fuse ratings;
- insulation, earthing and electrical isolation requirements;
- protection against overloading;
- protection against short circuit
- temperature rating and mechanical strength of flexible cables;
- portable electrical equipment;
- physical environment in which the equipment is used (e.g. wet or dusty atmospheres);
- frequency of electrical inspection and test;
- PAT testing and testing of the fixed installations; and
- suitable use and maintenance of personal protective equipment.

All electrical installations should be regularly maintained by a competent person, appointed by you, or on your behalf, in accordance with the Electricity at Work Regulations 1989 (EAW Regulations).²³ The use of low voltage equipment should conform to the requirements of the Electrical Equipment (Safety) Regulations 1994,²⁴ including the requirement to be CE marked.

1.6 Smoking

Carelessly discarded cigarettes and other smoking materials remain a major cause of fires. A cigarette can smoulder for several hours, especially when surrounded by combustible material.

Restricting smoking, or confining it to safe areas, is very effective in reducing fires arising from carelessly disposed of cigarette ends.

Consider operating a safe smoking policy in designated smoking areas and prohibiting smoking elsewhere. Display suitable signs throughout the premises informing people of the smoking policy and the locations where smoking is permitted. You may wish to make public address announcements about your smoking policy.

In those areas where smoking is permitted, provide deep and substantial metal ashtrays to help prevent unsuitable containers being used. Disposal of cigarette ends (undertaken at regular intervals) should be by a method that minimises ignition of a fuel and subsequent potential fire spread, e.g. into a metal waste bin which is then taken outside. It is dangerous to empty ashtrays into plastic waste sacks which are then left inside for disposal later.

Note: A particular concern for transport facilities is the potential for ignition of highly flammable substances (liquid fuels or gases) in those areas in which vehicles are maintained and/or refuelling operations take place. Smoking should be prohibited in those areas.

1.7 Managing building work and alterations

Fires are more frequent when buildings are undergoing refurbishment or alteration.

You should ensure that, before any building work starts, you have reviewed the fire risk assessment and considered what additional dangers are likely to be introduced. You will need to evaluate the additional risks to people, particularly in those buildings that continue to be occupied. Lack of pre-planning can lead to haphazard co-ordination of fire safety measures.

You should liaise and exchange information with contractors who will also have a duty under the Construction (Health, Safety and Welfare) Regulations 1996^{25, 26} to carry out a risk

assessment and inform you of their significant findings and the preventive measures they may employ. This may be supported by the contractors' agreed work method statement. The designer should also have considered fire safety as part of the Construction (Design and Management) Regulations 1994 (the CDM Regulations).²⁷

You should continuously monitor the impact of the building work on the general fire safety precautions, such as the increased risk from quantities of combustible materials and accumulated waste and maintaining adequate means of escape. You should only allow the minimum materials necessary for the work in hand within or adjacent to your building.

Activities involving hot work such as welding, flame cutting, use of blow lamps or portable grinding equipment can pose a serious fire hazard and need to be strictly controlled when carried out in areas near flammable materials. This can be done by having a written hot-work permit for the people involved (whether they are your employees or those of the contractor).

The purpose of the hot-work permit is to ensure that:

- the area is made as safe as possible before any hot working starts;
- monitoring and precautions continue to be taken while the work is in progress; and
- the area where the hot work was carried out, plus the surrounding area, are monitored for at least an hour after completion of the work.

A permit to work is appropriate in situations of high fire hazard/risk and, for example, where there is a need to:

- ensure that there is a formal check confirming that a safe system of work is being followed;
- co-ordinate with other people or activities;
- provide time limits when it is safe to carry out the work; and
- provide specialised personal protective equipment (such as breathing apparatus) or methods of communication.

Additional risks that can occur during building work include:

- temporary electrical equipment;
- blocking of escape routes, including external escape routes;

- introduction of combustibles into an escape route;
- loss of normal storage facilities;
- fire safety equipment, such as automatic fire-detection systems, becoming affected;
- fire-resisting partitions being breached or fire doors being wedged open (see Appendix B for information on fire-resisting separation); and
- additional personnel who may be unfamiliar with the premises.

You must notify the fire and rescue service about any proposed alterations in your premises if an alterations notice is in force.

Further guidance on fire safety during construction work is available from the HSE^{28, 29} and the Fire Protection Association.³⁰

1.8 Fire hazards in corridors and stairways used as escape routes

Items that are a source of fuel, pose an ignition risk, or are combustible and likely to increase the fire loading or spread of fire, should not be located on any corridor or stairway or circulation space that will be used as an escape route. Such items include:

- portable heaters, e.g. bottled gas (LPG) or electric radiant heaters and electric convectors or boilers;
- gas cylinders for supplying heaters;
- cooking appliances; and
- unenclosed gas pipes, meters, and other fittings;

However, depending on the findings of your risk assessment and where more than one escape route is available, the items below may be acceptable if the minimum exit widths are maintained and the item presents a relatively low fire risk:

- coat racks;
- non-combustible lockers;
- vending machines;
- small items of electrical equipment (e.g. photocopiers); and
- small quantities of upholstered furniture which meets BS 7176³² or the Furniture and Furnishings (Fire) (Safety) Regulations 1988.³¹

1.9 Restricting the spread of fire and smoke

To reduce the risk to people if there is a fire, you need to consider how to control or restrict the spread of fire and smoke. The majority of people who die in fires are overcome by the smoke and gases.

It is important to ensure that, in the event of fire, the rate of fire growth is restricted in its early stages. It should also be noted that most measures which restrict the rate of fire growth in its early stages will also serve to restrict the fire spread in its later stages.

Building layout and construction

To assess the risk in your premises you need to evaluate the layout and construction of your building. This does not mean a structural survey, unless you suspect that the structure is damaged or any structural fire protection is missing or damaged, but rather an informed look around to see if there are any easy paths through which smoke and fire may spread and what you can do to stop that. In general, older buildings will have more void areas, possibly hidden from view, which will allow smoke and fire to spread away from its source. Whatever your type of building, you may need to consider typical situations that may assist the spread of fire and smoke such as:

- large roof cavities;
- false ceilings, especially if they are not fire-stopped above walls;
- vertical shafts, e.g. lifts, open stairways, dumb waiters or service risers;
- voids behind wall panelling;
- unsealed holes in walls and ceilings where pipe work, cables or other services have been installed; and
- doors, particularly to stairways, which are ill-fitting or routinely left open.

In premises that are open plan and have large floor areas, e.g. a station concourse or waiting areas, there may be few restrictions to limit the spread of fire and smoke. Consequently, the movement of fire and smoke may:

- be faster than anticipated;
- impact upon a large number of users of the facility; and
- affect the availability of designated escape routes.

This may be a significant factor in:

- those facilities in which a void connects open mezzanine floors and gallery levels; and
- sub-surface railway stations accessed by pedestrian tunnels, where extended travel distances are possible.

Notwithstanding the above, the risk from fire and smoke spread may be reduced if you already have precautions in place that can limit the spread of fire and smoke. For example, the high roofs and large compartments (and possibly smoke control systems) found in many public concourses help to ensure that the escape routes are kept clear from smoke. Additionally, the strict control of materials helps limit fire spread. Where these features exist, you should seek advice from a competent person about the benefits that these offer.

Fire-resisting structures

Many buildings are divided into different areas by fire doors and fire-resisting floors, ceilings and walls. These are partly designed to keep a fire within one area, giving people more time to escape. You will need to identify which doors, floors, ceilings and walls in your building are fire-resisting. There may be information available from when the building was built, from when alterations have been made, or from a previously held fire certificate.

High-risk areas (e.g. plant rooms, machine rooms, store rooms containing explosive or highly flammable materials and areas set aside for storing combustible refuse) should be separated from the rest of the premises by appropriate fire-resisting construction.

Normally, if a wall is fire-resisting, then any doors in it will also need to be fire-resisting. If a wall, floor or ceiling is required to be fire-resisting then you should not make any holes in it, e.g. for pipe ducts, without consulting a competent person. Any fire-resisting doors should be appropriately marked 'Fire Door – Keep Shut' (or locked as appropriate), and fitted with a self-closing device where necessary. (See Appendix B for technical information about fire-resisting walls and doors.)

Combustible contents

Your premises will contain a range of combustible contents.

The use of furnishings and other materials which are easily ignited or have rapid spread of flame characteristics should be avoided.

You should seek to use materials that are less combustible, or, if there are no alternatives, those that have had some form of fire-retardant treatment. If combustible materials are present, they should be taken into account when determining the acceptability of escape routes.

Upholstered furniture should contain only those filling materials specified in the Furniture and Furnishings (Fire) (Safety) Regulations 1988³¹: covers shall comply with the requirements of BS 7176³² at the appropriate level.

If in doubt you should seek specialist advice with regards to the treatments and tests for these materials which can reduce their flammability and/or combustibility.

1.10 Arson

Recent studies indicate that, across all premises types, over 2,100 deliberately set fires, resulting in two deaths and 55 injuries, occur every week.* All premises can be targeted either deliberately or just because they offer easy access.

Be aware of other small, deliberately set fires in the locality, which can indicate an increased risk to your premises. Be suspicious of any small 'accidental' fires on the premises and investigate them fully and record your findings.

Fires started deliberately can be particularly dangerous because they generally develop much faster and may be intentionally started in escape routes. Of all the risk-reduction measures, the most benefit may come from efforts to reduce the threat from arson.

Measures to reduce arson may include the following:

- ensure the outside of the premises is well lit and, if practical, secure the perimeter of the premises;
- availability of CCTV cameras and security personnel and presence of staff;
- restrict access to materials or areas of the premises where deliberate fires can be set;
- thoroughly secure all entry points to the premises, including windows and the roof, but make sure this does not compromise people's ability to use the escape routes;
- remove automatic entry rights from staff who have been dismissed;

- ensure that your security alarm/fire-detection system is monitored and acted on;
- secure flammable liquids so that intruders cannot use them;
- remove all combustible waste regularly and ensure that any undergrowth around the site is cut down and removed; and
- do not place waste containers adjacent to occupied areas. Secure waste bins in a compound separated from occupied areas (this is particularly relevant when building work is in progress).

Further guidance on reducing the risk of arson has been published by the Arson Prevention Bureau.

1.11 Help for people with special needs

Of all the people who may be especially at risk you will need to pay particular attention to people who have special needs including those with a disability. The Disability Rights Commission estimates that 11 million people in this country have some form of disability, which may mean that they find it more difficult to leave a building if there is a fire. Under the Disability Discrimination Act 1995,¹² if disabled people could realistically expect to use your premises, then you must anticipate any reasonable adjustments that would make it easier for that right to be exercised.

The Disability Discrimination Act¹² includes the concept of 'reasonable adjustments'. For small transport premises, e.g. a small bus station, it may be considered reasonable to provide contrasting colours on a handrail to help people with vision impairment to follow an escape route more easily. However, it might be unreasonable to expect the same small premises to install an expensive voice-alarm system. In large transport premises and facilities, reasonable adjustments are likely to be much more significant.

If disabled people are likely to use your premises then you must provide a safe means for them to leave if there is a fire. You and your staff should be aware that disabled people may not react, or can react differently, to a fire warning or small fire. You should give similar consideration to others with special needs such as parents with young children or the elderly.

* Fire statistics UK, 2004: DCLG 2006.

In premises with a simple layout, a common-sense approach, such as offering to help lead a blind person or helping an elderly person down steps, may be enough. In more complex premises, more elaborate plans and procedures will be needed, with trained staff assigned to specified duties. In complex premises, you may also wish to contact a professional consultant or take advice from disability organisations.

While the majority of people with special needs wish to and are able to make their own escape, there may be a number who are only able to move or react adequately with assistance from staff.

Consider the needs of those with mental disabilities or spatial recognition problems. The range of disabilities encountered can be considerable, especially in transport facilities handling hundreds of thousands of people on a daily basis. Many of these can be addressed by properly trained staff, discreet and empathetic use of the 'buddy system' or by careful planning of colour and texture to identify escape routes. Buddy systems are commonly used by airlines where, depending on their disability, a disabled occupant may be escorted by a member of staff until their departure.

Where people with special needs use or work in the premises, their needs should, so far as is practicable, be discussed with them. These will often be modest and may require minor modifications to existing procedures. You may need to develop individual 'personal emergency evacuation plans' (PEEPs) for disabled persons who frequently use your premises. The advantage of this approach is that it pre-plans what is required in the event of an evacuation. Staff members will need to be confident of any PEEP that is put in place after consultation with them. As part of your consultation exercise you will need to consider the matter of personal dignity.

If members of the public use your premises then you may need to develop a range of standard PEEPs which can be provided on request to a disabled person or others with special needs.

Guidance of removing barriers to the everyday needs of disabled people is in BS 8300.³³ Much of this advice will also help disabled people during an evacuation.

You should also consider the particular needs of children and the elderly who may be using your premises. Similarly, special consideration

may be needed if members of the public are likely to be intoxicated.

Further advice can be obtained from the Disability Rights Commission at www.drc-gb.org.

Mobility impairment

The speed with which occupants are able to move is a critical factor in assessing the adequacy of fire measures in transport premises. Those considered particularly at risk are:

- persons with disabilities – typically, wheelchair users may be moved to a place of refuge prior to evacuation;
- groups of children under supervision – parent(s) with small children, school parties under the supervision of teachers; and
- persons unfamiliar with the facilities – e.g. visitors.

The frequency of traffic (arrivals/departures) and the potential impairment of the means of escape make the management of transport facilities in an emergency a particular challenge.

What you need to assess is:

- which routes the occupants will use;
- the effect that a person with reduced mobility may have on the evacuation of others;
- the adequacy of the means of escape for the mobility impaired, e.g. the provision of evacuation lifts, escalators, or devices that will enable people with reduced mobility to negotiate stairs, and the appropriate level of management to ensure that such operations are effective;
- the provision of refuge areas, where people can assemble for subsequent evacuation (by the management); and
- the need for additional resources to deal with expected occurrences or planned events where high numbers of people with disabilities will be in the premises at the time of a fire.

In many transport facilities the concept of progressive horizontal evacuation is used. This involves moving occupants to adjacent compartments or smoke zones. This can be particularly beneficial for those requiring assistance.

For further information on the principles of mobility impairment, see Part 2, Section 4.1 on pages 74.

Section 2 Further guidance on fire-detection and warning systems

General

If your transport facility has areas where a fire could develop undetected, or where people work alone and might not see a fire (e.g. a plant room in a station or a remote retail store in a terminal building), it may be necessary, depending on the risk, to install an automatic fire-detection and warning system. Otherwise, a suitable fire-warning system may be all that is required.

Unless your transport facility is small, such as a surface open-platform railway station, then your facility may be required to have an electrical fire-warning system. The need for, and the type of, fire alarm will be dependent on the findings of the risk assessment.

Typically, the fire alarm system will include:

- manual (break-glass) call points at storey exit and final exit locations;
- electronic sirens, bells, and/or voice alarms (providing the warning messages); and
- a control and indicator panel.

If, for any reason, your system fails, you must still ensure that people in your premises can be warned and escape safely. A temporary arrangement, such as whistles or air horns, combined with suitably trained staff located in key positions (to ensure that the whole premises are covered) may be acceptable for a short period pending system repairs.

The fire warning sound levels should be loud enough to alert everyone, taking into account background noise. Any sound systems should be muted (automatically or manually) when the fire-warning system sounds. In areas with uncontrollable high background noise, or where people may be wearing hearing protectors, the audible warning should be supplemented, e.g. with visual alarms.

Voice alarms

Research has shown that some people and, in particular, members of the public, do not always react quickly to a conventional fire

alarm. Voice alarms are therefore becoming increasingly popular and can also incorporate a public address facility. The message or messages sent must be carefully considered. It is therefore essential to ensure that voice alarm systems are designed and installed by a person with specialist knowledge of these systems.

Schematic plan

You should consider displaying a schematic plan showing fire alarm zones in a multi-zoned system adjacent to the control panel.

2.1 Manual call points

Manual call points, often known as 'break-glass' call points, enable a person who discovers a fire to raise the alarm immediately and warn other people in the premises of the danger. In transport premises, manual call points are not always necessary and should be considered in relation to the use and fire risk of the building.

People leaving a building or part of a building because of a fire will normally leave by the way they entered. Consequently, manual call points are normally positioned at exits that people may reasonably be expected to use in case of fire, not just those designated as fire exits. It is not necessary in every case to provide call points at every exit.

Manual call points should normally be positioned so that, after all fixtures and fittings, machinery and stock are in place, no one should have to travel more than 45m to the nearest alarm point. This distance may need to be less if your premises cater for people of limited mobility or there are particularly hazardous areas. They should be conspicuous (red), fitted at a height of about 1.4m (or less for premises with a significant number of wheelchair users), and not in an area likely to be obstructed.

Conventionally sited call points that operate an immediate general fire warning are not

desirable in large transport facilities. To reduce the risk of malicious or accidental operation which may promote unnecessary evacuations in the event of an actuation by a member of the public, as part of your management plan you should consider alternative arrangements such as:

- locating the majority of manual call points in staff areas;
- the guarding of manual call points;
- the use of CCTV to allow management to confirm the outbreak of fire; and
- a delayed alarm for investigation purposes before any general alarm is given.

Areas that are well managed or regularly checked and patrolled may have less need for a manual call point. For these approaches to be effective, robust management procedures should be in place around a staff alarm system (see Section 2.3 below).

2.2 Automatic fire detection

Automatic fire detection may be needed for a number of reasons. These can include:

- if your premises include areas where people are isolated or remote and could become trapped by a fire because they are unaware of its development, e.g. lone workers;
- if your premises include areas where a fire can develop unobserved, e.g. storerooms, plant rooms, machine rooms, escalators and travelators (especially where these form part of the means of escape);
- if your premises include smoke control and/or ventilation systems that are controlled by the automatic fire-detection system; and
- as a compensatory feature, e.g. for inadequate structural fire protection or where the escape travel distances exceed the recommended maximum.

When considering the need for automatic fire protection you should take into account places where the effect of fire could have a higher impact than would normally be the case, for example a fire in shops, offices, staff rooms or other accommodation in sub-surface railway stations may have a higher impact on the means of escape than a fire in a similar location on a surface station.

If you have an automatic fire-detection system, the system should:

- be designed to accommodate the emergency evacuation procedure;
- provide an automatic indication of the fire warning and its location (at the control point, repeater panels and any other nominated location);
- be maintained and tested by a competent person; and
- communicate with a central control room (if you have one).

New automatic fire-detection systems should be designed and installed by a competent person in accordance with the advice given in BS 5839-1³⁵ or a more recent standard where applicable.

Where the public address system is part of the fire-warning system it should be connected to an auxiliary power source to ensure the continued use of the system in the event of fire or other emergency.

Whichever warning or detection systems are in place, the fire and rescue service should always be called immediately if a fire occurs.

2.3 Fire-warning systems

The fire alarm master control panel should be in a location that is both accessible and visible to the fire and rescue service, usually in the main entrance. If the master control panel is not sited in the main entrance then a repeater panel should also be located at the control point.

Where there is a need for a dedicated control room (e.g. airport or large station terminal) and a repeater panel is provided, it should run silently, or have a mute facility, so that if it goes off it will illuminate a prominent red or flashing light rather than make a warning sound. This is so that there will be no extra noise to disrupt communications within the control room. If the repeater panel is located elsewhere, it will require a designated individual to monitor it.

Interface with building management systems

Building management systems and controls include a variety of systems designed for the control, monitoring and optimisation of various

functions and services provided in a building (including heating and cooling, ventilation and lighting). In premises with a building management system there can be benefits in having links between the building management system and the fire-detection and alarm system to ensure that the operation (or non-operation) of essential services is not detrimental to the performance of the system. This holistic view of how all the systems operate on a fire signal will, normally, be recorded on a cause and effect matrix. When carrying out regular testing, it is important that the cause and effect is re-validated to ensure that all systems have the correct functionality in case of fire.

Staff alarms, voice evacuation systems and public address systems

Staff alarms (delayed alarms) allow staff to be aware of an incident in advance of the public and be prepared for an evacuation (and, potentially, to reduce false alarms – see Section 2.4 below). You may wish to use code words to warn of an evacuation, or of some other action required. It is important, however, that such communications should not result in a significant reduction in the time available for escape by the public.

Voice evacuation systems and public address systems can give staff and the public explicit information about the emergency. You should consider what information to provide, and how to communicate it succinctly.

Voice alarms

Research has shown that some people, particularly members of the public, do not always react quickly to a conventional fire-warning system.

Voice alarms, therefore, are very important in transport facilities where there is a high level of public occupancy.

The message, or messages, given in a fire emergency must be carefully considered. While the voice alarm will need to achieve an appropriate level of audibility, the RASTI index (which measures the clarity of speech) is an important consideration. It is essential to ensure that a voice alarm system is designed and installed by a person with specialist knowledge of these systems.

The provision of a combined public address/voice alarm system is a common feature of many large modern transport facilities: it also allows

the use of coded messages for fire investigation as part of an agreed management response to activation of a device.

You may wish to provide information to other users of the premises regarding warning signals, escape routes, muster points or other pertinent information, e.g. during the induction of prospective tenants and contract staff.

You or your staff should have direct control of the public address system. The system should be designed and installed to BS 5839-1.³⁵ Section 7 of BS 5588-6³⁴ provides useful additional advice.

People with hearing difficulties

Where users of the transport facility may have a hearing impairment, particularly those who are profoundly deaf, then simply hearing the fire warning is likely to be the major difficulty.

If these persons are never alone while on the premises, it is reasonable for other occupants to let them know that the building should be evacuated. They may also be prompted by visual cues of people leaving the premises. However, this should not be relied on as a means of alerting people with hearing difficulties.

If a person with hearing difficulties is likely to be alone (e.g. a member of staff), consider other means of raising the alarm. Alternative means of raising the alarm for the hearing impaired include:

- vibrating devices/pagers (linked to the fire alarm) – for members of staff;
- visual beacons (linked to the fire alarm) – for both members of staff and the public; and
- managed evacuations – to assist the evacuation of people at special risk.

If voice evacuation systems and/or public address systems are used to indicate specific courses of action, consideration should be given to the provision of visual aids to indicate the action required to those with a hearing impairment.

2.4 Reducing false alarms

False alarms from automatic fire-detection systems are a major problem and result in

many unwanted calls to the fire and rescue service every year. Guidance on reducing false alarms has been published by DCLG/CFOA/BFPSA.³⁶

If there are excessive false alarms in your premises, the public and staff may become complacent and not respond correctly to a warning of a real fire. In such circumstances, you may be failing to comply with fire safety law. All false alarms should be investigated to identify the cause of the problem and remedial action taken promptly.

To help reduce the number of false alarms, the system design and the location of detection and activation devices should be reviewed against the way the premises are currently used. For example, if a store room has been converted to a staff area with cooking facilities (e.g. a microwave and toaster), then the likelihood of the detector being set off is increased. Similarly, if a manual call point is placed in a storage area where there is continual movement of stock, the call point is likely to be accidentally damaged. In this case a simple, fabricated, hinged metal guard around the call point is likely to solve the problem.

There are many initiatives which can be implemented to address the problem of false alarms. These include:

- effective system specification and design to suit the environment in which the system is installed, e.g. do not locate a smoke detector near cooking appliances or designated smoking areas;
- a system configuration designed to minimise false alarms consistent with acceptable system performance in terms of life and property protection;
- the competent commissioning of the system to the requirements of a detailed specification;
- the establishment of challenging targets for the improvement of the false alarm performance of systems and the commitment of all parties to achieve these targets; and
- regular system maintenance by a competent person with the responsibility for false alarm resolution.

Further detailed guidance on reducing false alarms is available in BS 5839-1.³⁵

2.5 Staged fire alarms

In many facilities sounding the fire-warning system should trigger the immediate and total evacuation of the building. However, in many large or complex terminals or stations this may not be necessary or desirable, and alternative arrangements should be in place.

These alternative arrangements broadly fall into two groups. Firstly, those people potentially most at risk from a fire, usually those closest to where the alarm was activated, will be evacuated immediately, while others in the premises are given an alert signal message and will only evacuate if it becomes necessary. This is generally called a managed phased evacuation, and the initial movement, depending on the layout and configuration of the premises, can be either horizontal or vertical. This is a common approach in airport terminals and some stations which have the benefit of size (large volume), long distances from the fire incident and/or smoke control zones, which allow the evacuation of persons into adjacent zones.

The second option is for the initial alert signal to be given to certain staff, who then carry out pre-arranged actions to help others evacuate more easily (see Staff alarms – Part 2, Section 2.3 above). It requires able, fully-trained staff to be available at all times and should not be seen as a simple means of reducing disruption. Where staged alarms are being used, disabled people should be alerted during the first stage to give them the maximum possible time to escape.

These arrangements both require fire-warning systems capable of giving staged alarms, including an ‘alert signal’ and a different ‘evacuate signal’, and should only be considered after consultation with specialist installers and, if necessary, the relevant enforcing authority.

Such systems also require a greater degree of management input to ensure that staff and others are familiar with the system and the action required.

2.6 Testing and maintenance

Your fire-warning and/or detection system should be supervised by a named responsible person, who has been given enough authority and training to manage all aspects of the routine testing and scrutiny of the system.

All types of fire-warning systems should be tested regularly in accordance with the guidance in the relevant British Standard. For electrical systems a manual call point should be activated (using a different call point for each successive test), usually by inserting a dedicated test key (see Figure 24). This will check that the control equipment is capable of receiving a signal and, in turn, activating the warning alarms. Manual call points may be numbered to ensure they are sequentially tested.

Figure 24: Using a test key

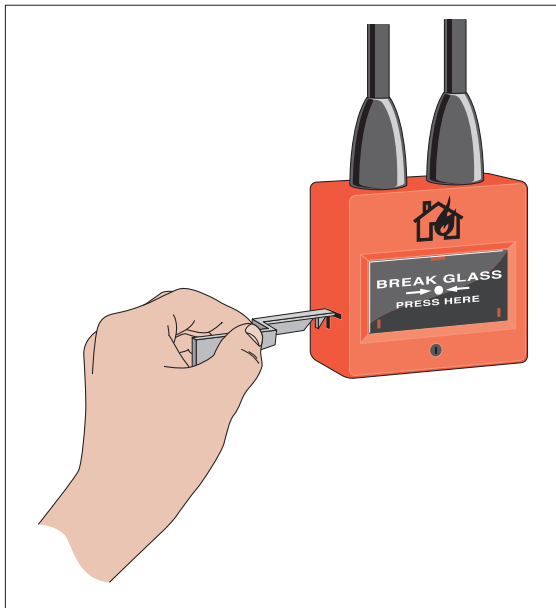

It is good practice to test the alarm at the same time each week, but additional tests may be required to ensure that staff or people present outside normal working hours are given the opportunity to hear the alarm.

Where systems are connected to a central monitoring station, arrangements should be made prior to testing to avoid unwanted false alarms.

Six-monthly servicing and preventive maintenance should be carried out by a competent person with specialist knowledge of fire-warning and automatic detection systems. This task is normally fulfilled by entering into a service contract with a specialist fire alarm company.

It is good practice to record all tests, false alarms and any maintenance carried out.

Further guidance on testing and maintenance of fire-warning systems can be found in BS 5839-1.³⁵

2.7 Guaranteed power supply

Generally, a large transport facility will need an electrical fire-warning system, and the Health and Safety (Safety Signs and Signals) Regulations 1996¹³ requires the system to have a back-up power supply.

Whatever back-up system is used, it should normally be capable of operating the fire-warning and detection system for a minimum period of 24 hours and sounding the alarm signal in all areas for 30 minutes.

2.8 New and altered systems

Guidance on the design and installation of new systems and those undergoing substantial alterations is given BS 5839-1.³⁵ If you are unsure that your existing system is adequate you will need to consult a competent person.

Section 3 Further guidance on firefighting equipment and facilities

All transportation facilities should be provided with appropriate firefighting equipment. For the majority of premises, first aid firefighting equipment should be sufficient. However, at some larger or more complex premises it may be necessary to provide a suitable water supply for firefighting in the form of hydrants.

You have responsibility for the provision of appropriate firefighting equipment. It is also your responsibility to check that all firefighting equipment is in the correct position and in satisfactory order before the premises are used by the public.

Appropriate staff should be trained in the use of all such equipment.

3.1 Portable firefighting equipment

Fire extinguishers provided should be appropriate to the specific risks found in your premises in accordance with Table 1. This table also shows the different classes of fire, according to what is burning.

Table 1: Class of fire

Class of fire	Description
Class A	Fires involving solid materials such as wood, paper or textiles.
Class B	Fires involving flammable liquids such as petrol, diesel or oils.
Class C	Fires involving gases.
Class D	Fires involving metals.
Class F	Fires involving cooking oils such as deep-fat fryers.

Note: If there is a possibility of a fire in your premises involving material in the shaded boxes then you should seek advice from a competent person.

Number and type of extinguishers

Typically, for the Class A fire risk, the provision of one water-based extinguisher for approximately every 200m² of floor space, with a minimum of two extinguishers per floor, will normally be adequate.

Where it is determined that there are additionally other classes of fire risk, the appropriate type, number and size of extinguisher should be provided. Further information is available in BS 5306-8.³⁷

Where the fire risk is not confined to a particular location, e.g. Class A fires, the fire extinguishers should be positioned on escape routes, close to the exit from the room or floor, or the final exit from the building. Similarly, where the particular fire risk is specifically located, e.g. flammable liquids, the appropriate fire extinguisher should be near to the hazard, so located that they can be used safely. They should be placed on a dedicated stand or hung on a wall at a convenient height so that employees can easily lift them off (at about 1m for the larger extinguishers, 1.5m for smaller ones, to the level of the handle). Ideally, no one should have to travel more than 30m to reach a fire extinguisher. If there is a risk of malicious use you may need to use alternative, more secure, locations.

Consider the implications of the Manual Handling Operations Regulations 1992³⁸ when selecting and siting firefighting equipment.

In self-contained small premises, multi-purpose extinguishers which can cover a range of risks may be appropriate. Depending on the outcome of your fire risk assessment, it may be possible to reduce this to one extinguisher in very small premises with a floor space of less than 90m².

Extinguishers manufactured to current standards (BS EN 3-7³⁹) are predominately red but may have a colour-coded area, sited above or within the instructions, denoting the type of extinguisher. Most older extinguishers, manufactured to previous standards, have bodies painted entirely in a single colour which denotes the type of extinguisher. These older extinguishers remain acceptable until they are no longer serviceable. However, it is good practice to ensure that old and new style extinguishers are not mixed on the same floor of a building.

The following paragraphs describe different types of extinguisher. The colour referred

to is the colour of the extinguisher or the colour-coded area.

Water extinguishers (red)

This type of extinguisher can only be used on Class A fires. They allow the user to direct water onto a fire from a considerable distance. A 9-litre water extinguisher can be quite heavy and some water extinguishers with additives can achieve the same rating, although they are smaller and therefore considerably lighter. This type of extinguisher is not suitable for use on live electrical equipment.

Water extinguishers with additives (red)

This type of extinguisher is suitable for Class A fires. They can also be suitable for use on Class B fires and, where appropriate, this will be indicated on the extinguisher. They are generally more efficient than conventional water extinguishers.

Foam extinguishers (cream)

This type of extinguisher can be used on Class A or B fires and is particularly suited to extinguishing liquid fires such as petrol and diesel. They should not be used on free-flowing liquid fires unless the operator has been specially trained, as these have the potential for rapid fire spread to adjacent material. This type of extinguisher is not suitable for deep-fat fryers or chip pans.

Powder extinguishers (blue)

This type of extinguisher can be used on most classes of fire and achieve a good 'knock down' of the fire. They can be used on fires involving electrical equipment but will almost certainly render that equipment useless. Because they do not cool the fire appreciably it can re-ignite. Powder extinguishers can create a loss of visibility and may affect people who have breathing problems, and they are not generally suitable for confined spaces.

Carbon dioxide extinguishers (black)

This type of extinguisher is particularly suitable for fires involving electrical equipment as they will extinguish a fire without causing any further damage (except in the case of some electronic equipment, e.g. computers). As with all fires involving electrical equipment, the power should be disconnected if possible.

Class 'F' extinguishers

This type of extinguisher is particularly suitable for commercial catering establishments with deep-fat fryers.

Selection, installation and maintenance of portable fire extinguishers

All portable fire extinguishers will require periodic inspection, maintenance and testing. Depending on local conditions such as the likelihood of vandalism or the environment where extinguishers are located, carry out brief checks to ensure that they remain serviceable. In normal conditions a monthly check should be enough. Maintenance by a competent person should be carried out annually.

New fire extinguishers should comply with BS EN 3-7.³⁹ Guidance on the selection and installation of fire extinguishers is given in BS 5306-8,³⁷ for maintenance in BS 5306-3,⁴⁰ and for colour coding in BS 7863.⁴¹

Fire blankets

Fire blankets should be located in the vicinity of the fire hazard they are to be used on, but in a position that can be accessed safely in the event of a fire. They are classified as either light duty or heavy duty. Light-duty fire blankets are suitable for dealing with small fires in containers of cooking oils or fats and fires involving clothing. Heavy-duty fire blankets are for industrial use where there is a need for the blankets to resist penetration by molten materials.

3.2 Fixed firefighting installations

These are firefighting systems which are normally installed within the structure of the building. They may already be provided in your premises or you may be considering them as a means of protecting some particularly dangerous or risk-critical area as part of your risk-reduction strategy.

Hose reels

Permanent hose reels (see Figure 25) installed in accordance with the relevant British Standard (see BS EN 671-3⁴²) provide an effective firefighting facility. They may offer an alternative, or be in addition to, portable firefighting equipment. A concern is that untrained people will stay and fight a fire when escape is the safest option. Where hose reels are installed, and your fire risk assessment expects relevant staff to use them in the initial stages of a fire, they should receive appropriate training.

Figure 25: Hose reel

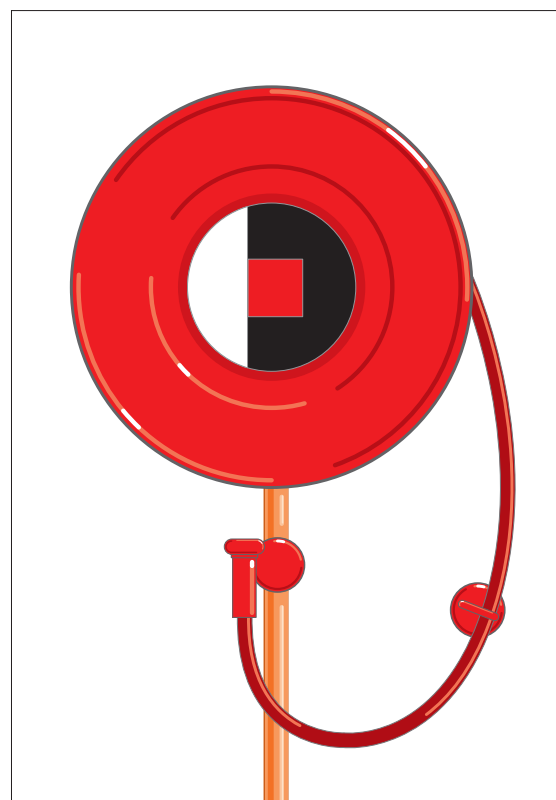

Maintenance of hose reels includes visual checks for leaks and obvious damage, which should be carried out regularly. A competent person should carry out more formal maintenance checks at least annually.

Sprinkler systems

Sprinkler systems can be very effective in controlling fires. They can be designed to protect life and/or property and may be regarded as a cost-effective solution for reducing the risks created by fire. Where installed, a sprinkler system is usually part of a package of fire precautions in a building and may form an integral part of the fire strategy for the building.

Guidance on the design and installation of new sprinkler systems and the maintenance of all systems is given in the Loss Prevention Council (LPC) rules, BS EN 12845⁴³ and BS 5306- 2⁴⁴ and should only be carried out by a competent person. Routine maintenance by on-site personnel may include checking of pressure gauges, alarm systems, water supplies, any anti-freezing devices and automatic booster pump(s). For example, diesel fire pumps should be given a test run for 30 minutes each week.

A competent maintenance contractor should provide guidance on what records need to be completed.

Following a sprinkler operation, the sprinkler system should be re-instated by a competent person. A stock of spare sprinkler bulbs should be available on-site, preferably in a separate building, e.g. the pump house.

If a sprinkler system forms an integral part of your fire strategy, it is imperative that adequate management procedures are in place to cater for those periods when the sprinkler system is not functional. This should form part of your emergency plan. Although the actual procedures will vary, such measures may include the following:

- Restore the system to full working order as soon as possible.
- Limit any planned shutdown to low-risk periods when the numbers of people are at a minimum (e.g. at night), or when the building is not in use. This is particularly important when sprinklers are installed to a life-safety standard or form part of the fire safety engineering requirements.
- Isolate the area without working sprinklers from the rest of the premises by fire-resisting material.
- Avoid higher-risk processes such as 'hot-work'.
- Extra staff should be trained and dedicated to conducting fire patrols.
- Any phased or staged evacuation strategy may need to be suspended. Evacuation should be immediate and complete. (Exercise caution as the stairway widths may have been designed for phased evacuation only.)
- Inform the local fire and rescue service.

If, having considered all possible measures, the risk is still unacceptable then it will be necessary to close all or part of the building. If in doubt you should seek the advice of a competent person.

Other fixed installations

There are a number of other fixed installations including local application water mist systems, local application gaseous systems, water deluge systems, foam pourers and fixed powder systems. If your premises have a fixed firefighting system that you are unfamiliar with, then seek advice.

Where a fixed firefighting system forms an integral part of your fire safety strategy, it should be maintained in accordance with the relevant British Standard by a competent person.

3.3 Other facilities (including those for firefighters)

Building regulations and other Acts, including local Acts, may have required firefighting equipment and other facilities to be provided for the safety of people in the building and to help firefighters. Fire safety law places a duty on you to maintain such facilities in good working order at all times.

These may include:

- access for fire engines and firefighters;
- firefighting shafts and lifts;
- fire suppression systems, e.g. sprinklers, and water mist and gaseous systems;
- smoke-control systems;
- dry or wet fire mains and firefighting inlets and outlets;
- information and communication arrangements, e.g. fire telephones and wireless systems and information to brief the fire and rescue service when they arrive; and
- firefighters' switches.

The Workplace (Health, Safety and Welfare) Regulations 1992⁴⁵ require that systems provided for safety within a workplace are maintained.

Access for fire engines and firefighters

Buildings that have been constructed to modern building regulations or in accordance with certain local Acts will have been provided with facilities that allow fire engines to approach and park within a reasonable distance so that firefighters can use their equipment without too much difficulty.

These facilities may consist of access roads to the building, hard standing areas for fire engines and access into the building for firefighters. It is essential that, where such facilities are provided, they are maintained properly and are available for use at all relevant times.

Where a building is used by a number of different occupants you will need to ensure co-operation between the various 'responsible

people' to maintain access for the fire and rescue service. In exceptional cases, where access is obstructed persistently, you may need to make additional arrangements.

See Approved Document B to the Building Regulations⁴⁶ for more information.

Firefighting shafts and lifts

Firefighting shafts (see Figure 26) are provided in larger buildings to help firefighters reach floors further away from the building's access point. They enable firefighting operations to start quickly and in comparative safety by providing a safe route from the point of entry to the floor where the fire has occurred.

Figure 26: Firefighting shaft

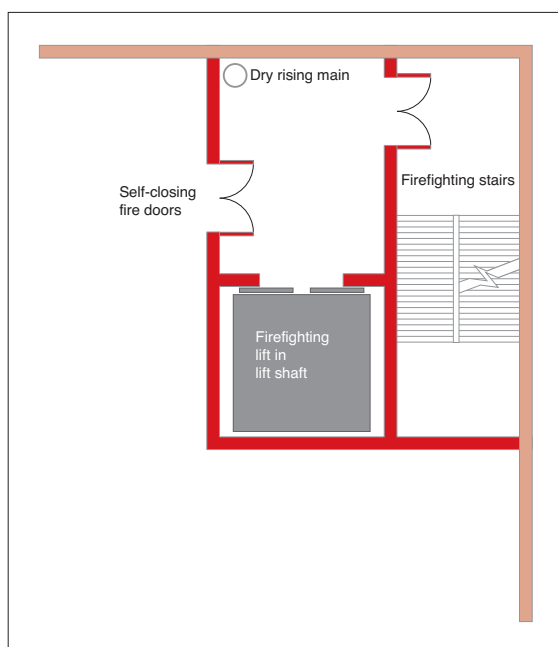

Entry points from a stairway in a firefighting shaft to a floor will be via a lobby, through two sets of fire and smoke-resisting doors and walls. Many people will use the stairway for normal movement through the building and it is important that the safety features are not compromised by doors being wedged open.

Most firefighting shafts will also incorporate a firefighting lift which opens into the lobby. The lift will have a back-up electrical supply and car control overrides. The primary function of the lift is to transport firefighting personnel and their equipment to the scene of a fire with the minimum of time and effort. It may also be used to help evacuate less mobile people.

Alterations that might affect the shaft should not be made without first liaising with other responsible persons, any owners or managing agents and the enforcing authority. Any proposed changes may require building regulation approval from a building control body.

Where a firefighting shaft is provided, the construction and components should be maintained by a competent person.

Fire suppression systems

Fire suppression systems can include sprinklers and other types of fixed installations designed to automatically operate and suppress a fire. Such systems should be maintained in accordance with the guidance in Section 3.2.

Smoke control systems

These are complex systems that are provided for life safety of occupants, assistance to firefighters and property protection by clearing hot smoke and gases from the building. If you have one of these systems provided in your premises you should ensure you understand how it operates and that it is maintained in full working order. If your system is part of a larger system then you should liaise with other occupiers and building managers.

The smoke control system should be maintained by a competent person who is familiar with the fire engineering performance specifications of that specific system.

Where these systems are installed in addition to a sprinkler system, the design and installation of each system should not act detrimentally on one another. A competent person should be employed to confirm this.

Dry and wet fire mains

The rising fire main (see Figure 27) is an important facility for the fire and rescue service in taller buildings. It consists of an inlet box where firefighters can connect their hoses, a pipe running up or through the building, outlet valves on each floor level and an air vent at the top.

Figure 27: Rising main

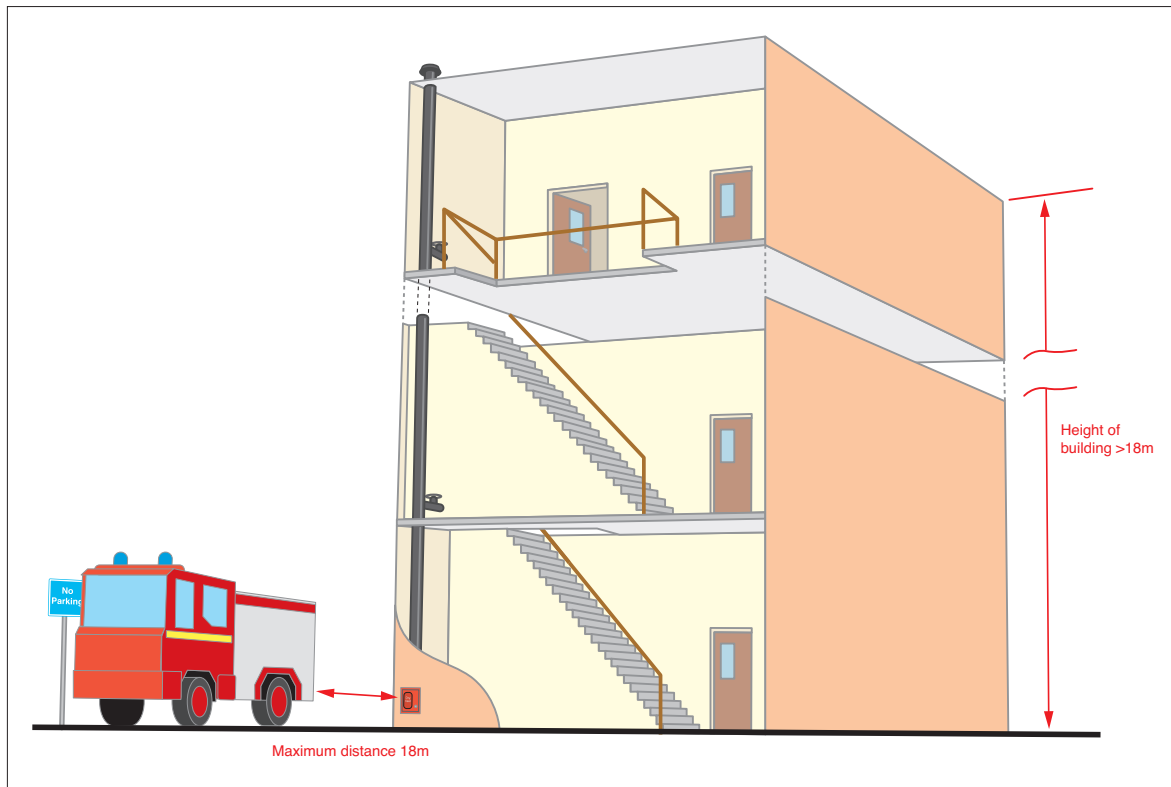

It is important that fire mains remain in good working order. Issues you should consider include the following:

- The physical approach to the inlet box should be such that a fire engine can park within 18m with the inlet box in view.
- Prohibit car parking in front of the inlet box.
- Secure the inlet box in such a way that firefighters can open the door without too much difficulty.
- It is advisable to lock the landing valves in the closed position, usually with a leather strap and padlock.

Foam inlets

These special inlets are usually fitted to provide an efficient way of extinguishing a fire in areas of high risk, such as a plant room. In many respects they look the same as rising main inlet boxes, but the door should be clearly marked 'foam inlet'. The risk area should be kept clear of obstructions to allow the foam to spread into the compartment.

Maintenance of fire main inlets

All types of rising mains and foam inlets, together with associated valves, should be maintained and tested on a regular basis by a competent person. Guidance on inspection and testing of dry and wet rising mains is given in BS 5306-1.⁷⁸ Although there are no recommended periods between maintenance checks for foam inlets, it would be prudent to carry out an annual service.

Firefighters' switches

Safety switches are normally provided to isolate high-voltage luminous signs or to cut off electrical power. In the case of existing installations, if they have been provided in accordance with previous legislation (e.g. the Local Government (Miscellaneous Provisions) Act 1982⁴⁷), then it is likely that they will comply with the Order.¹ If this is not the case, then you may need to consult the enforcing authority regarding the suitability of its location and marking. Testing should be carried out in accordance with the manufacturer's instructions. If you have no such instructions then an initial test should be carried out by a competent electrician.

Other firefighting facilities

As well as those already mentioned, other facilities to assist firefighters may have been installed in your premises and should be properly maintained by a competent person. Your fire risk assessment, emergency plan and maintenance audit (see Appendix A for an example checklist) should include these. Such facilities can include:

- information signs for firefighters;
- static water supplies, private hydrants, meter bypass valves and underground tanks;
- standby fire pumps, electrical generators, air pumps and hydraulic motors; and
- manual/self-closing devices for roller shutter doors in fire compartment walls.

Section 4 Further guidance on escape routes

Introduction

This section provides guidance on the general principles that apply to escape routes and provides examples of typical escape route solutions for a range of building layouts.

You are not obliged to adopt any particular solution for escape routes but you must ensure that your solution is safe. Premises (or parts of premises) perceived to be at increased risk may require one or more additional fire protection/precaution measures to ensure the adequacy of the escape route provision.

Transport premises are designed primarily to move people in the process of using a transportation system. A significant proportion of the space within the premises is used as circulation and waiting areas for people in the process of either catching or transferring from one method of transportation to another. Transport premises can also contain a significant proportion of support accommodation, such as ticket offices, staff accommodation, baggage handling facilities and passenger lounges, as well as other accommodation ancillary to the business such as shops, offices and hotels that open on to shared concourse areas.

Guidance is given on how to evaluate the escape routes in these different areas, particularly where they share common escape routes. It may also be appropriate to use other guidance documents in this series to complete your risk assessment.

In larger or more complicated premises, it is good practice to use the fire strategy that was developed when the premises was developed or constructed as the basis for your risk assessment. It is also likely that you will need to take advice from a competent person and liaise closely with other relevant parties who occupy the premises. It is also likely that if your transportation premises are used by significant numbers of people, the advice of a competent person should be sought. This section gives guidance on how you can assess the suitability of the escape routes in your premises.

Transport premises may be in the open, semi-enclosed (canopied shelters and platforms), underground or in enclosed buildings. Each of these facilities has a different level of risk, requiring a different approach to the design of means of escape. Time and distance are the two main parameters used to help define the means of escape requirements. The following sections provide you with guidance on these matters.

Refer to the Glossary (Appendix D) for the definitions of any terms you may not be familiar with.

Levels of risk

In order to apply the guidance in this section, you need to understand that, in any fire situation, the time people have to escape before they could become affected by the fire is limited. Providing them with sufficient time usually requires that, as well as having an appropriate way of detecting and giving warning in case of fire, the distance that people have to travel to make their escape to a place of reasonable or total safety must be restricted. This can be done by calculating the time needed to evacuate the premises, and controlling the hazards presented by a fire so that people are not placed at undue risk during this time. Alternatively, by restricting the distance that people have to travel to reach a place of safety or relative safety, the same result can be achieved. If your premises have travel distances greater than the guidance given in this document, or of an assessment of the suitability of the escape routes based on the time available to escape, it is likely that you would need to use the guidance of a competent person.

You will need to form a judgement about the level of risk in the premises and the level of residual risk once you have taken risk reduction measures, both preventative and protective.

An escape route may take people through differing levels of risk. Where an escape route from support accommodation is dependent on the circulation area of the transport premises, both portions of the escape route need to be taken into account. It may also be the case that

people have to escape from areas of relative safety, such as open-air platforms, through buildings which form part of the escape route.

It is important to evaluate the total level of risk throughout the escape route, which may vary. For example, the risk to people evacuating from a shop into a large concourse area, in, for example, a large rail interchange or airport, with high ceilings and large volumes, will probably decrease once the people leave the shop environment. In this situation the total travel distance may be greater than that specified in the guidance for a shop environment. However, if the shop opens into a concourse area that is fully enclosed, it will be appropriate to restrict travel distances to those recommended.

Therefore, it is important to recognise that, in the initial stages of an evacuation, people can be evacuated to a place of reasonable safety, where they are protected either by the inherent nature of the premises, such as large premises' volumes and distances and high ceilings, or by being in the open air but within the premises. This protection can also be provided by passive fire protection, such as fire compartmentation, or by active fire-protection systems such as automatic fire suppression systems, for example sprinklers, and smoke control.

By their very nature, transport premises have significant areas next to activities that may pose a risk to people, such as railway permanent way, airside areas with aircraft and maintenance activity, waterways associated with ports, or roadways at bus stations. In assessing escape routes, it is important to evaluate the risk of evacuating people into these or adjacent areas. Appropriate measures will need to be taken if this is necessary, either by providing dedicated escape routes, or by providing appropriate management and levels of staffing to guide people safely to a place of safety.

Figure 28: Commuters in a busy railway terminal



Escape times

The following information is provided to demonstrate the range of escape times available to you in the assessment of your premises.

Escape times may be only a proportion of the total evacuation time for your premises as people move progressively away from the fire. The escape time is the time taken to move to a place of reasonable safety, while the evacuation time is the time taken to empty the entire premises. Care should be taken on the use of terms to describe escape or evacuation and to what part of your premises they apply.

When calculating evacuation times, you should take account of the slowest rate of egress. You should also review the protective and preventative measures provided, to ensure that they are taken into account in the calculated escape time. Further guidance can be found in BS 7974.⁵⁴ If you feel that this approach is appropriate, it is likely that you will need the advice of a competent person.

However, where you have long travel distances (such as those found in many transport premises, e.g. airport gates, ferry piers and railway platforms), other means can be utilised to ensure that escape routes are free from smoke for a longer period of time, such as the provision of natural or mechanical smoke extraction or control.

For example, an initial review of a railway platform with long travel distances could indicate that the means of escape from the platform is at risk from the effects of smoke in the event of a fire. However, there may be mitigating features that reduce the risk, e.g. above-ground station platforms may be covered by a canopy but, as they are open to the air, any smoke trapped under the canopy is likely to spill from underneath and disperse into the environment (Figure 29). Where the platforms are totally enclosed, a smoke reservoir (high ceilings), permanent vents or a dedicated smoke extraction system may be present to control the smoke fill, enabling safe egress for the occupants (Figure 30).

Figure 29: A canopied waiting area



Figure 30: A covered railway station



4.1 General principles

Suitability of escape routes

Escape routes are designed so that people can escape quickly enough to ensure that they are not placed in any danger from fire. The time available will depend on a number of factors, including the number of escape routes available, the nature of the occupants, the number of exits and the rate of fire spread. Smooth, unimpeded flow through an exit route is best achieved by ensuring that the exit system does not narrow along the length.

You should ensure that your escape routes are:

- accessible for use by all those likely to use them;
 - suitable for use by all those likely to use them;
 - adequate for the number of people likely to use them;
 - easily, safely and immediately usable at all times;
 - usable without passing through doors requiring a key (or code) to unlock them;
- free from any obstructions, slip or trip hazards;
 - well lit by normal or emergency escape lighting; and
 - available for access by the emergency services.

All doors on escape routes should open in the direction of escape and, ideally, be fitted with a safety vision panel. This is particularly important if more than 60 people are expected to use them at any one time or they provide an exit from an area of high fire risk.

Rail, bus and air terminals are generally designed with good ingress and egress to ensure the most efficient movement of passengers throughout the building; if possible, the escape routes should reflect the general access routes, as passengers will use the routes they are familiar with.

Most new, complex facilities are designed to cope with the maximum foreseeable number of occupants. The capacity of the means of escape is designed to enable all occupants to evacuate before they are affected by the movement of smoke and hot gases. In existing sub-surface stations, it is not practical to construct additional exits to serve all areas. The capacity of escape routes in sub-surface stations is limited, and the provision of escalators as a means of escape to facilitate rapid evacuation is an established protocol.

The time to evacuate occupants should be as short as is reasonably practicable.

Some general considerations for the provision of means of escape are itemised below:

- All areas forming part of a means of escape must be fully available at all times.
- Corridors, stairs, escalators, travelators, lifts and other means of escape should be free of obstructions and/or combustibles at all times.
- Doors required to open to facilitate escape should not be locked (or the locking mechanism should be de-activated on activation of the fire alarm).
- Doors held open and arranged to close in a fire emergency should be in operating order and should not be compromised by other devices and/or objects (e.g. wedges).

- All exits and exit routes forming the means of escape should be distinctively marked by notices indicating the emergency exit or route from the premises.
- All parts of the premises forming the means of escape should be provided with artificial lighting capable of providing sufficient illumination. Emergency lights (plus directional and exit signs) should have two independent sources of power supply.
- the spread of fire and smoke may be heavily influenced by the background flow of air through the tunnels, particularly in long stations where the piston effect from the movement of vehicles is significant.

In these situations, it may be appropriate to reduce the inherent flammability, fire loading and toxicity of the materials within the circulation areas that form the escape routes. For example, concrete, non-reactive metals and/or ceramics could form the major part of the underground facility wherever possible.

Organic-based materials may be acceptable provided that they meet strict criteria relating to their flammability and their smoke and toxic fume emission characteristics. The requirements imposed are dependent on the use of the material and the environment in which it is located. For example:

- The requirements for rolling stock interiors are more onerous than those for sub-surface stations due to the smaller dispersal volume for heat, smoke and toxic fumes.
- The requirements for the surfaces of walls and ceilings are more stringent than those for floors to reflect the manner in which fire grows and spreads.

In existing sub-surface facilities it may be extremely difficult to satisfy the current requirements. In this case, the use of fire compartmentation to separate areas with a fire load from circulation areas, fire suppression systems and extensive automatic fire alarm systems can be seen as suitable preventative and protection measures, which will mean that the extended escape routes are acceptable. It is likely that the advice of a competent person will be needed to help you complete a risk assessment of a sub-surface railway station.

Particular considerations associated with open-air rail platforms

Many railway stations have long platform lengths that are either in dead-end conditions or have extended travel distances. They also have the added risk that the use of the permanent way would not be appropriate in the initial stages of an evacuation without the assistance of staff. However, in these situations people are often in a place of relative safety because they are in the open air, there are very high roof structures with large volumes, and/or they are often physically separated or remote from any fire hazard associated with the station buildings or rolling stock.

Where two escape routes are necessary, and to further minimise the risk of people becoming trapped, you need to consider whether the escape routes are independent of each other. This will prevent a fire affecting more than one escape route at the same time.

It is essential that escape routes, and the means provided to ensure that they are used safely, are managed and maintained to ensure that they remain usable and available at all times when the premises are occupied. Inform staff in training sessions about the escape routes within the premises.

Corridors (including cross-passages into adjoining tunnels) and stairways that form part of escape routes should be kept clear and hazard-free at all times. Items that may be a source of fuel or pose an ignition risk should never be located on any corridor or stairway that will be used as an escape route. In some premises with storage racking, escape routes may be through or under the racking, in which case the routes should be kept clear of any storage or obstructions.

Particular considerations associated with sub-surface facilities

When a significant proportion of the sub-surface rail infrastructure was built, the requirements for means of escape were not understood in a way that would be recognised now. In many of these older facilities, it is recognised that the escape routes exceed current design guidance. This does not mean that they are unsafe. Alternative protection and prevention measures have been used in these situations because:

- escape distances can be extremely long compared with other premises and can contain extended dead-end conditions;
- existing facilities are unlikely to be fitted with smoke control systems or with fire and smoke separation throughout the escape routes; and

In these situations, the risk assessment should take into account:

- the travel distance involved and fire-warning systems available to initiate the evacuation. If the route through a station area is of low fire risk and there is adequate early warning, it may be possible to extend travel distances;
- that people will be in a place of reasonable safety if the escape route is blocked. In this case, staff should be available to take charge of the ultimate evacuation to a place of total safety and protect people from the dangers associated with the permanent way; and
- that in certain areas and at certain times stations will be used by relatively few members of the travelling public and may be unstaffed. The management should ensure that, in the event of a fire, staff can be alerted to attend the incident.

In these situations, it is likely that the adequacy of the escape routes will be based on passenger flow figures and time to safety calculations. Advice from a competent person would probably be required.

Number and type of people using the premises

As your escape routes need to be adequate for the number of people likely to use them, you will need to consider how many people, including employees and the public, may be present at any one time. Where premises have been subject to building regulations approval for use as a transport facility, the number and width of escape routes and exits will normally be adequate for the anticipated number of people using the premises. If the facility was constructed before national building regulations were in place or if the risk has changed (e.g. the passenger throughput has increased), it will be necessary to confirm the provision. In busy transport premises, the use of passenger flow information based on timetables, the passenger capacity of the mode of transport, floor space factors and the experience of members of staff

can be used to work out the number of people likely to use the premises. In ancillary areas and support accommodation, it would be appropriate to use either the number of staff using these areas or a figure based on the floor area and floor space factors.

The maximum number of people likely to be in the building at any one time will be known by the responsible person. In some parts of the premises (e.g. a departure lounge) the responsible person will normally be aware of the maximum number of people likely to be present, times of the year when maximum numbers of travellers may be expected, and the proportion of travellers having special needs (e.g. a mobility impairment, parents with children, the elderly) from personal knowledge of use patterns.

In those facilities handling large numbers of people, the number of people entering the premises may need to be monitored. If the numbers of people entering the premises is too great, then procedures may be needed to:

- limit the number of people entering the premises (e.g. the temporary shutdown of ticket barriers and/or entrances);
- control the numbers of people within specific areas; and/or
- prevent migration between areas.

If you propose to make changes to either the use or the layout of the building such that the occupancy of the premises might increase, you should check the design capacity of the building by referring to relevant guidance.

Mobility impairment

Effective management arrangements need to be put in place for those who need help to escape.

BS 5588-8⁹ indicates that suitable provision is to be made within the building to allow disabled occupants to move away from the fire to a place of relative safety. The general principle can be summarised as follows:



Consider the following points:

- A refuge is a place of reasonable safety in which disabled people can wait either for an evacuation lift or for assistance up or down stairs (see Figure 31). Disabled people should not be left alone in a refuge area while waiting for assistance to evacuate the building. Depending upon the design and fire resistance of other elements, a refuge could be a lobby, corridor, part of a public area or stairway, or an open space such as a balcony or similar place which is sufficiently protected (or remote) from any fire risk and which is provided with its own means of escape and a means of communication.

Figure 31: An example of a refuge

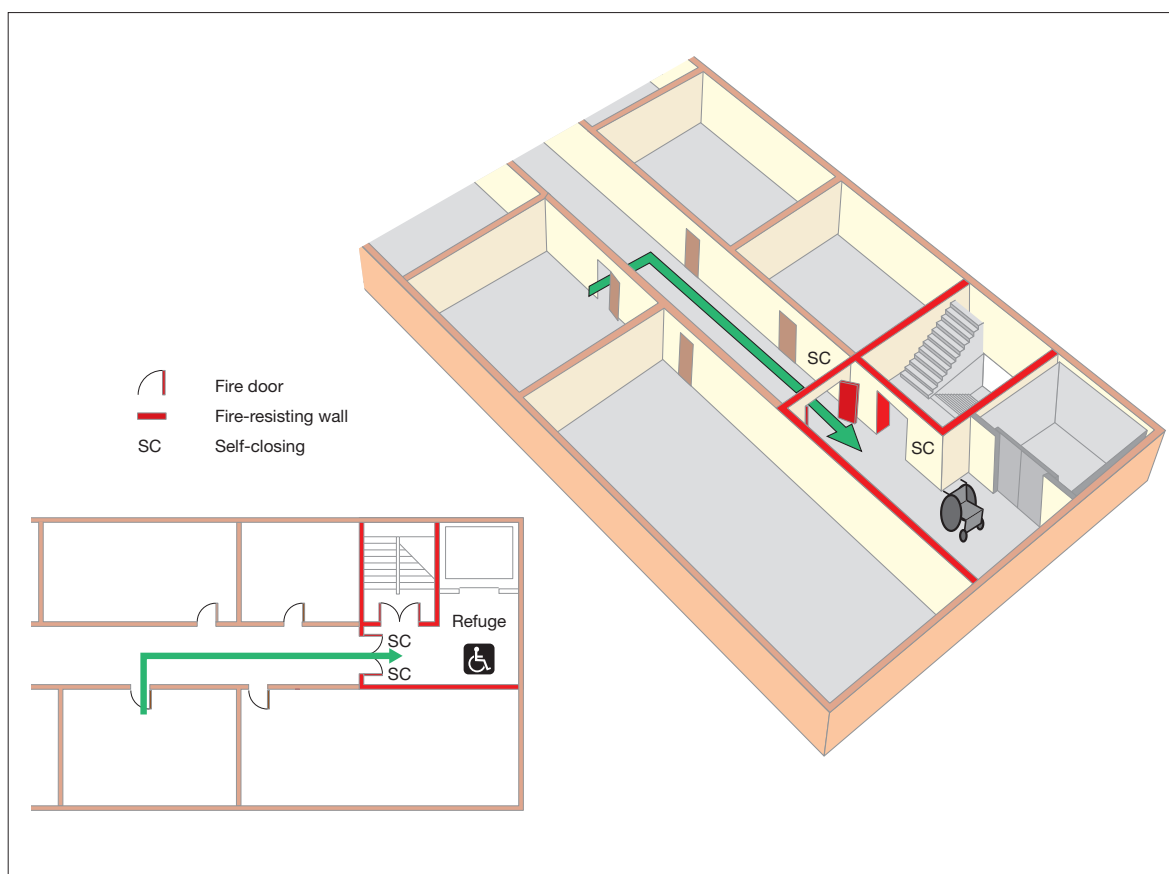

- Where refuges are provided, they should be enclosed in a fire-resisting structure which creates a protected escape route which leads directly to a place of total safety and should only be used in conjunction with effective management rescue arrangements. Your fire safety strategy should not rely on the fire and rescue service to rescue people waiting in these refuges. Refuges should include two-way communications with the premises management and/or fire and rescue service.
- If firefighting lifts (provided in high buildings for firefighting access) are to be used for evacuation, this should be co-ordinated with the fire and rescue service as part of the pre-planned evacuation procedures.
- Normal lifts may be considered suitable for fire evacuation purposes, subject to an adequate fire risk assessment and development of a suitable fire safety strategy by a competent person (further guidance is provided in BS 5588-12¹⁵).
- A disabled person, having reached a refuge, should be able to gain access to an alternative escape route.
- Sufficient escape routes should always be available for use by disabled people. This does not mean that every exit will need to be adapted. Staff should be aware of routes suitable for disabled people so that they can direct and help people accordingly. Specialist evacuation chairs or other equipment may be necessary to negotiate stairs.
- Plans should allow for the careful carrying of disabled people down stairs without their wheelchairs, should the wheelchair be too large or heavy. You will need to take into account health and safety manual handling procedures in addition to the dignity and confidence of the disabled person.
- Stairlifts should not be used for emergency evacuation. Where installed in a stairway used for emergency evacuation, no parts of the lift, such as its carriage rail, should be allowed to reduce the effective width of the stairway or any other part of an emergency evacuation route.
- Where ramps are necessary for the emergency evacuation of people in wheelchairs they should be as gentle as possible. Guidance is given in the Building Regulations Approved Document M.⁴⁸

It should not be assumed that everyone who uses a wheelchair is not able to walk at all; some people may be able to walk enough to leave the building with assistance, and this should be provided by staff at the premises.

Further guidance is available in BS 5588-8⁴⁹ and BS 5588-12.¹⁵

Widths and capacity of escape routes and stairways

Once you have established the maximum number of people likely to be in any part of the premises, the next step is to establish that the capacity of the escape routes is adequate for people to escape safely and in sufficient time to ensure their safety in case of fire.

The capacity of a route is determined by a number of factors including the width of the route, the time available for escape and the ability of the persons using them.

The effective usable width of an escape route is the narrowest point, normally a door or other restriction such as narrowing of a corridor due to fixtures and fittings. The capacity of an escape route is measured by the number of persons per minute that can pass through it, so, to establish the capacity of the route, it is first necessary to measure the width of the route at the narrowest point. The effective width of a doorway is the clear unobstructed width through the doorway when the door is open at right angles to the frame. The effective width at any other point is the narrowest clear unobstructed width through which people can pass.

The time available for escape depends on several factors including the distance that has to be travelled to reach a place of safety and the risk rating of the premises. Established reasonable escape times are 2 minutes for higher risk premises, 2.5 minutes for normal risk premises and 3 minutes for lower risk premises. For calculation purposes these times are allowed for in the travel distances suggested in Table 2 on page 78. (It should be noted that these times may be extended in passenger circulation areas. If this is the case, then it is probably advisable to seek the advice of a competent person.) Guidance on establishing the risk rating of your premises is given earlier in this section.

The following guide can be used to determine the general capacities of escape routes:

A width of at least 750mm can accommodate up to:

- 80 people in higher risk premises;
- 100 people in normal risk premises; or
- 120 people in lower risk premises.

A width of at least 1,050mm can accommodate up to:

- 160 people in higher risk premises;
- 200 people in normal risk premises; or
- 240 people in lower risk premises.

An additional 75mm should be allowed for each additional 15 persons (or part of 15).

The minimum width of an escape route should ideally be 1,050mm but in any case not less than 750mm (unless it is for use by less than five people in part of your premises) and, where wheelchair users are likely to use it, not less than 900mm.

The aggregate width of all the escape routes should be not less than that required to accommodate the maximum numbers of people likely to use them.

When calculating the overall available escape route capacity for premises that have more than one way out, you should normally assume that the widest is not available because it has been compromised by fire. If doors or other exits leading to escape routes are too close to one another you should consider whether the fire could affect both at the same time. If that is the case, it may be necessary to discount them both from your calculation.

As a general rule, stairways should be at least 1,050mm wide and in any case not less than the width of the escape routes that lead to them. In all cases the aggregate capacity of the stairways should be sufficient for the number of people likely to have to use them in case of fire.

Stairways wider than 2,100mm should normally be divided into sections, each separated from the adjacent section by a handrail, so that each section measured between the handrails is not less than 1,050mm wide.

Travel distance

Having established the number and location of people and the exit capacity required to evacuate them safely, you now need to confirm that the number and location of existing exits is adequate. This is normally determined by the distance people have to travel to reach them.

Table 2 on page 78 gives guidance on travel distances. It should be understood, however, that these distances are flexible and may be increased or decreased depending upon the level of risk after you have put in place the appropriate fire-prevention measures. In premises where a fire engineered solution has been adopted (such as large airport terminals and sub-surface railway stations), use of the advice below about travel distances may not be appropriate because other mitigation factors (such as smoke extraction) will have been brought into play to allow longer travel distances. Specialist advice will be needed where fire engineered solutions have been used. This is also the case for railway platforms and large concourses where the evacuation procedures will be detailed in the emergency plan for the station.

In new buildings which have been designed and constructed in accordance with modern building standards appropriate travel distances (taking into account any compensatory features such as engineered solutions) will already have been calculated. Once you have completed your fire risk assessment you need to confirm that those distances are still relevant. When assessing travel distances you need to consider the distance to be travelled by people when escaping allowing for walking around furniture or display stands etc. The distance should be measured from all parts of the premises to the nearest place of reasonable safety which is:

- a protected stairway enclosure (a storey exit);
- a separate fire compartment from which there is a final exit to a place of total safety
- the nearest available final exit.

Table 2: Suggested travel distances (not for larger complex transport premises)

Escape routes	Suggested range of travel distance: areas with seating in rows	Suggested range of travel distance: other areas
Where more than one escape route is provided	20m in higher fire risk area ¹ 32m in normal fire risk area 45m in lower fire risk area ²	25m in higher fire risk area ¹ 45m in normal fire risk area 60m in lower fire risk area ²
Where only a single escape route is provided	10m in higher fire risk area ¹ 15m in normal fire risk area 18m in lower fire risk area ²	12m in higher fire risk area ¹ 18m in normal fire risk area 25m in lower fire risk area ²

Note 1:

Where there are small higher risk areas this travel distance should apply. Where the risk assessment indicates that the whole building is higher risk, seek advice from a competent person.

Note 2:

The travel distance for lower risk premises should only be applied in exceptional cases in the very lowest risk premises where densities are low, occupants are familiar with the premises, excellent visual awareness, and very limited combustibles.

The travel distances given in Table 2 are based on those recommended in Approved Document B of the Building Regulations²⁴ and are intended to complement the other fire safety recommendations in Approved Document B.⁴⁶ Your current escape route travel distances may be different from these since they may be based on recommendations made in alternative guidance. Where your route leads to more than one final exit, but only allows initial travel in a single direction (e.g. from a room or dead end, see Figures 35), then this initial travel distance should be limited to that for a 'single escape route' in Table 2. However, your total travel distance should not exceed that for 'more than one escape route'.

You will need to form a judgement about the level of risk in the premises and the level of residual risk once you have taken other risk reduction measures, both preventative and protective.

In premises where there is a likelihood of a fire starting and spreading quickly (or a fire could start and grow without being quickly detected and a warning given) and affect the escape routes before people are able to use them then the risk should normally be regarded as 'higher'. Such premises could include those where significant quantities of flammable materials are used or stored, ready sources of ignition are present, e.g. heat producing machinery and processes; premises where significant numbers of the people

present are likely to move slowly or be unable to move without assistance; and premises where the construction provides hidden voids or flues through which a fire could quickly spread.

In premises where there is a low occupancy level and all the occupants are able bodied and capable of using the means of escape without assistance; very little chance of a fire; few if any highly combustible or flammable materials or other fuels for a fire; fire cannot spread quickly; and will be quickly detected so people will quickly know that a fire has occurred and can make their escape, then the risk can usually be regarded as 'lower'. In most cases however, the risk will usually be 'normal'.

The travel distances suggested are not hard and fast rules and should be applied with a degree of flexibility according to the circumstances. For example, in premises where the risk might otherwise be considered 'normal' but where there are a significant number of people who move slowly or may need assistance to evacuate, it would usually be appropriate to consider this a 'higher' risk. However, where other measures are in place to mitigate this, such as the availability of extra assistance and this has been planned for in your emergency plan, it may be that the risk level can be regarded as 'normal to higher'.

Equally, in premises where the risk category would otherwise be 'lower' but for the fact that a small number of occupants may move slowly

or need assistance, it may be appropriate to categorise the risk as 'normal' in these circumstances.

If you are not sure about the level of risk that remains in your premises, you should seek advice from a competent person. This may be particularly relevant if the escape route travels through different areas of risk, such as from a ticket office into a passenger circulation area. If the travel distance in your premises exceeds these distances to a place of safety it does not mean necessarily mean that it is unacceptable. However, you are advised to seek the guidance of a competent person.

Measuring travel distance

The figures that follow are schematic only and are intended to represent part of a larger building. They are intended to give guidance on what may be acceptable in support and ancillary accommodation. The principles can also be used to assess areas open to members

of the public in such situations in smaller premises.

The route taken through a room or space will be determined by the layout of the contents. It is good practice to ensure routes to exits are kept as direct and short as possible. In a small room there may be only one exit but in a larger room or area there may be many exits. In some cases, where the contents are moved around or the space is liable to frequent change, e.g. in a storage area or where racking is movable, you should ensure that the exits, or the routes to them, do not become blocked or the length of the route is not significantly extended.

Alternative exits

Where alternative exits from a space or room are necessary, they should wherever possible be located at least 45° apart (see Figure 33) unless the routes to them are separated by fire-resisting construction (see Figure 34). If in doubt consult a competent person.

Figure 32: Alternative exits

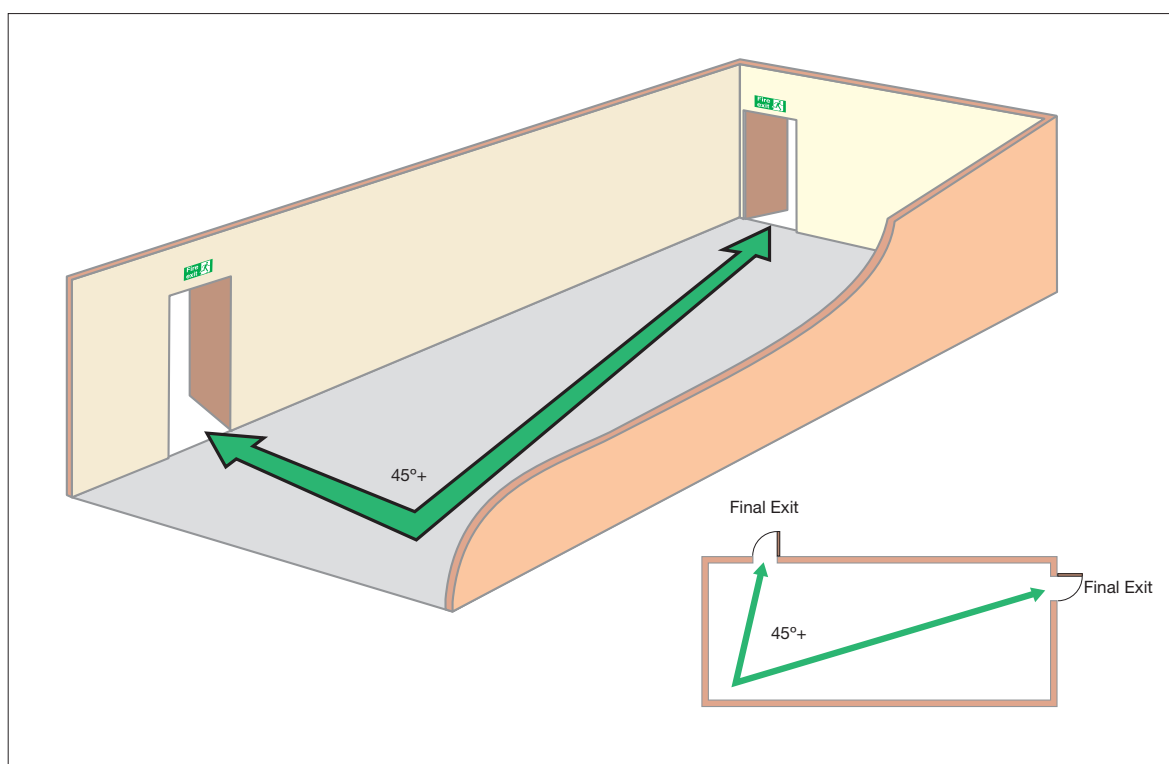
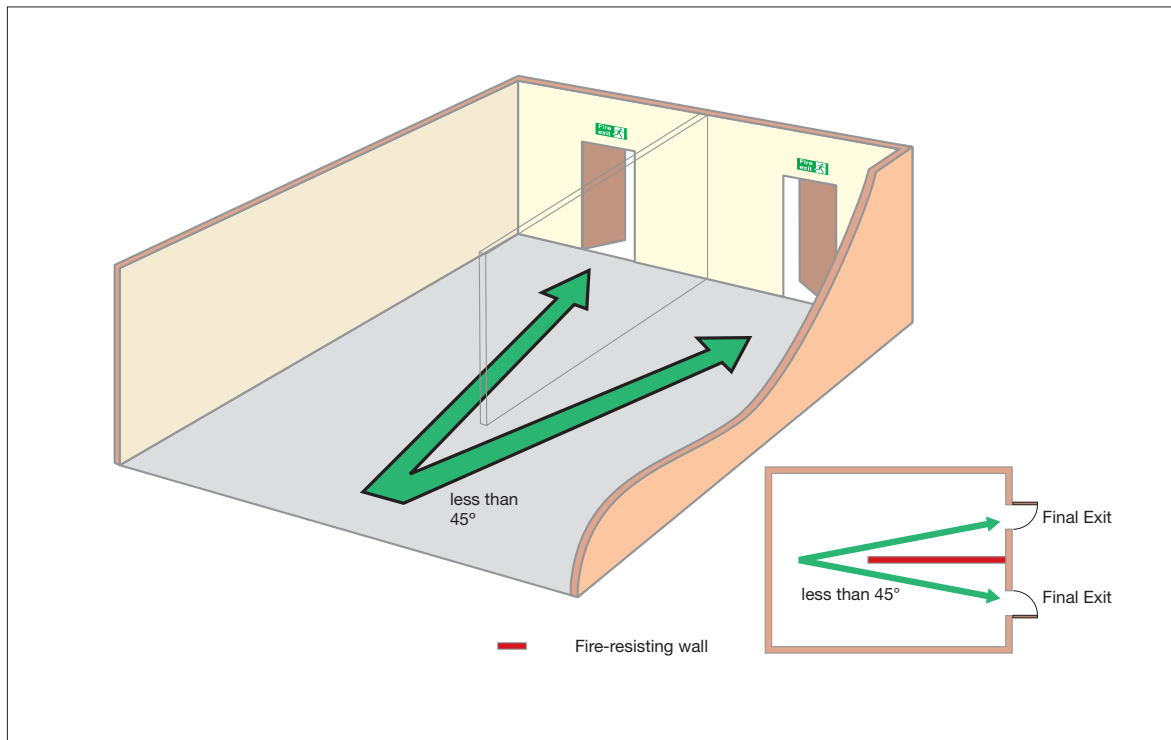

Figure 33: Alternative exits
(separated by fire-resisting construction)



Inner rooms

Where the only way out of a room is through another room (Figure 34), an unnoticed fire in the outer room could trap people in the inner room. This layout should be avoided where possible. If, however, this cannot be achieved, then adequate warning of a fire should be provided by **any one** of the following means:

- a vision panel between the two rooms providing adequate vision to give an indication of the conditions in the outer room and the means of escape;
- a large enough gap between the dividing wall and the ceiling, e.g. 500mm, so that smoke will be seen; or
- an automatic smoke detector in the outer room that will sound a warning in the inner room.

In addition, the following points should also be considered:

- Restrict the number of people using an inner room to 60.
- Access rooms should be under the control of the same person as the inner room.
- The travel distance from any point in the inner room to the exit from the access room should be restricted to escape in one direction only (see Table 2 on page 78), unless there are alternative exits from the access room.
- No one should have to pass through more than one access room while making their escape.
- The access room should not be an area of high fire risk.

Figure 34: Inner rooms

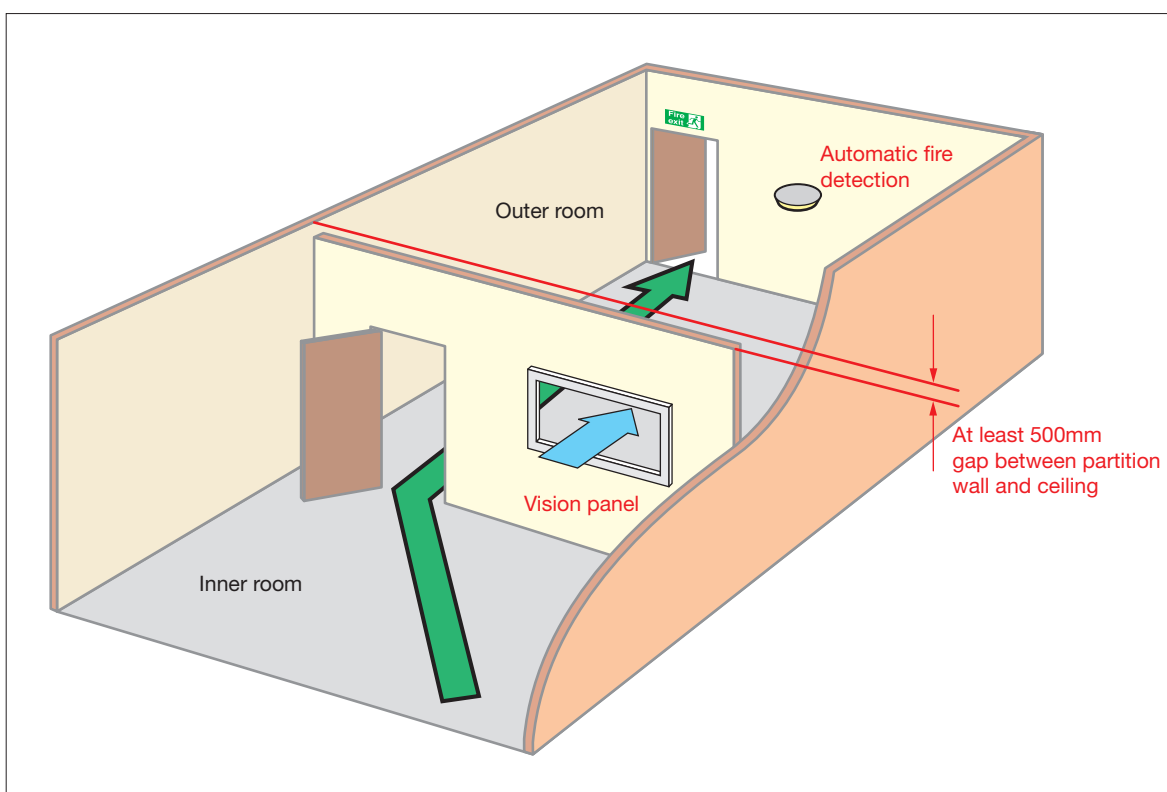

Note: Additional measures are necessary to give warning of fire for inner rooms.

Escape routes with dead-end conditions

If your premises has escape routes from which escape can be made in one direction only (a dead end), then an undetected fire in that area could affect people trying to escape. To overcome this problem, limit the travel distance (see Table 2 on page 78) and use one of the following solutions:

- Fit an automatic fire-detection and warning system in those areas where a fire could present a risk to the escape route (see Figure 36).
- Protect the escape route with fire-resisting construction to allow people to escape safely past a room in which there is a fire (see Figure 37).
- Provide an alternative exit (see Figure 38).

Alternative approaches may be acceptable, although expert advice may be necessary.

Figure 35: Measuring travel distance from initial dead end (inner room)

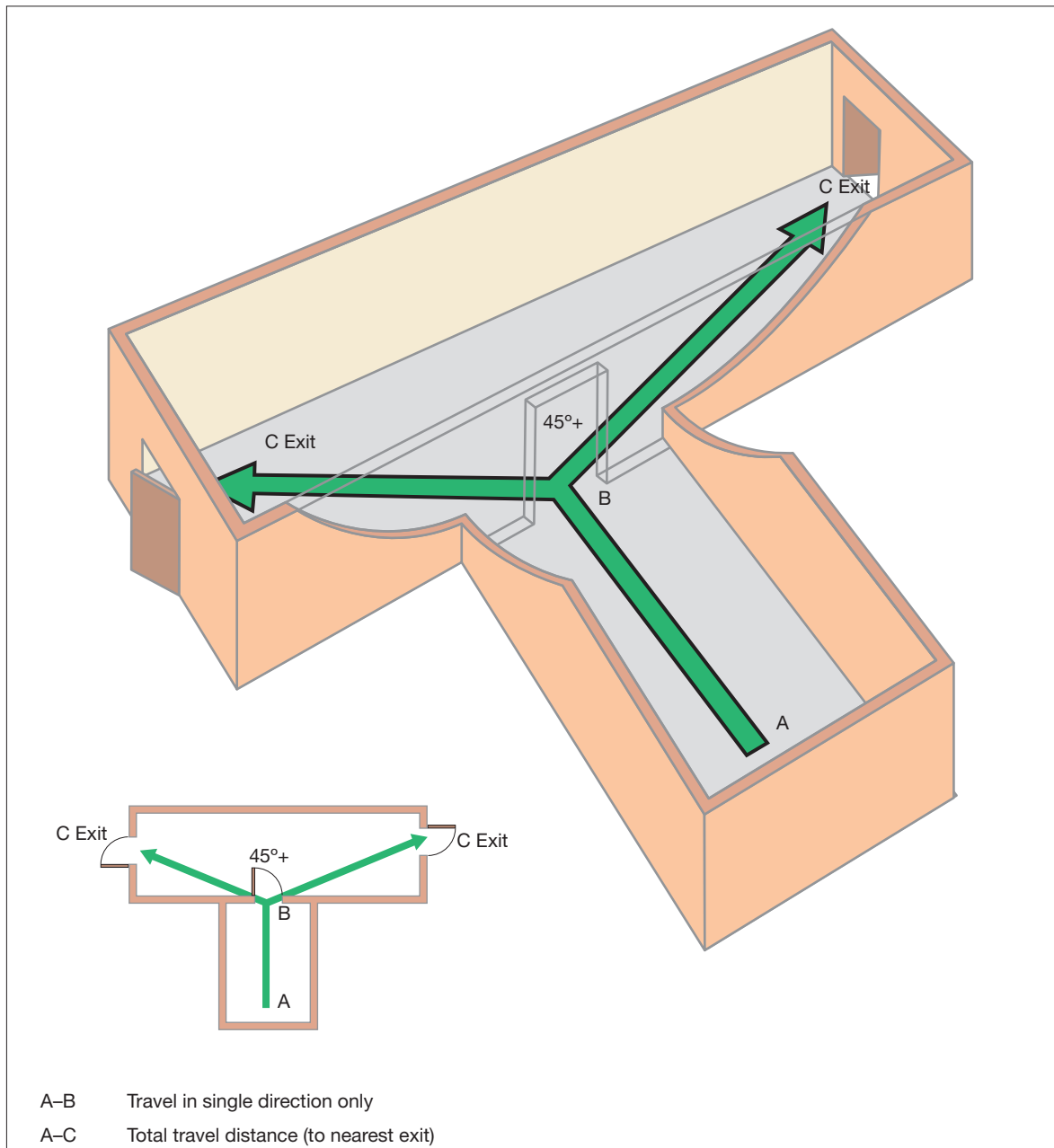

Figure 36: Dead-end condition with automatic fire detection

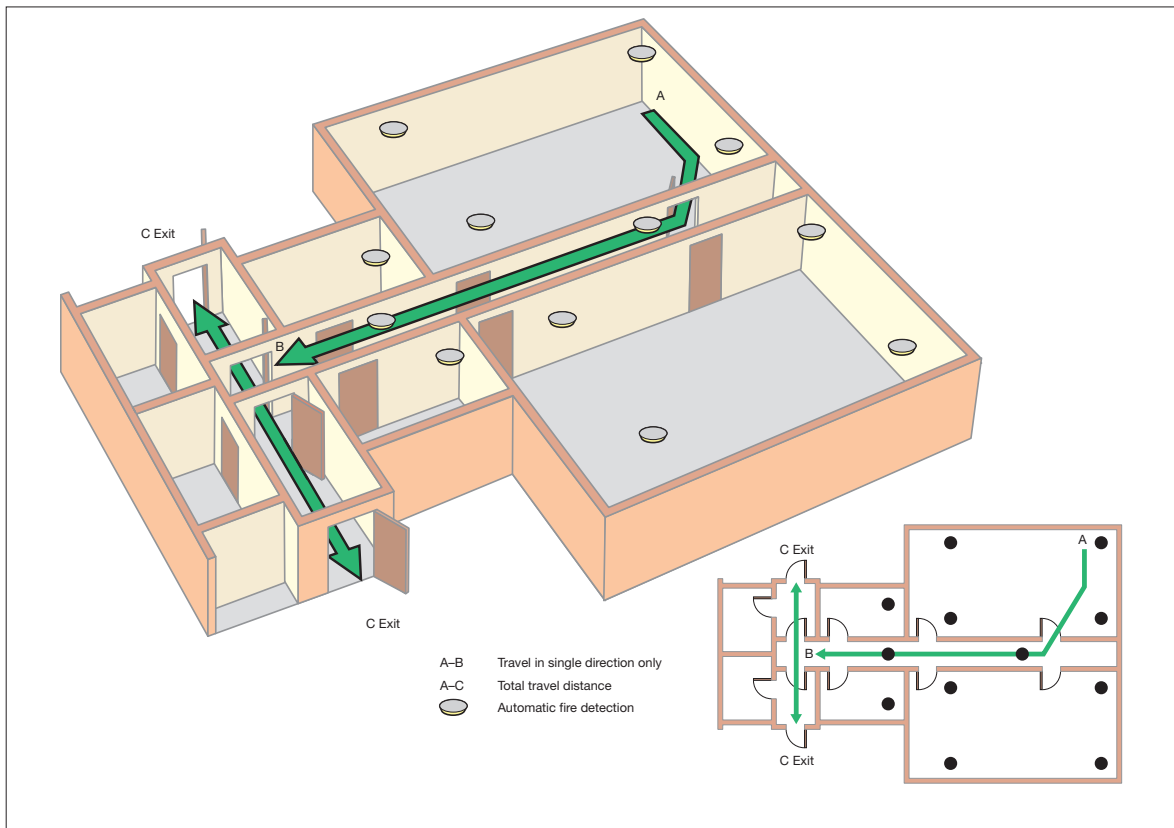
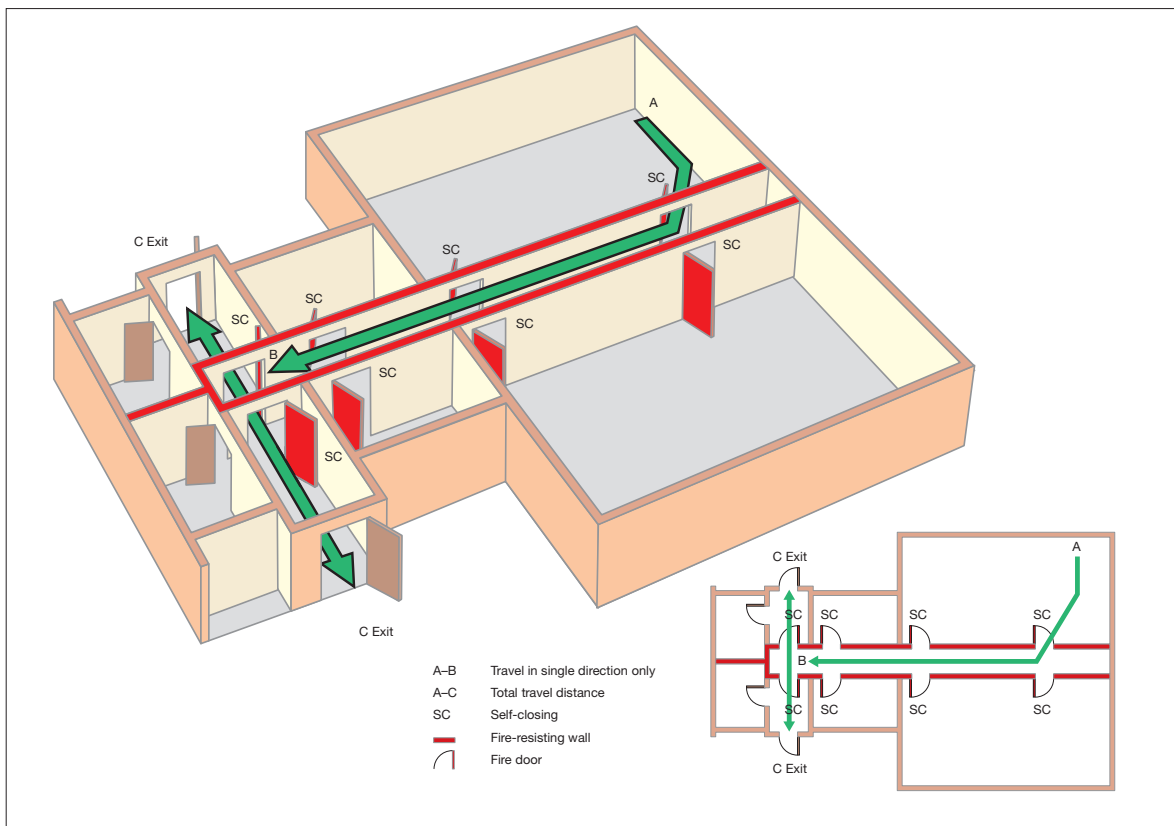

Figure 37: Dead-end condition with fire-resisting construction



Basements: escape and protection

Note: This section does not apply to sub-surface facilities.

In all buildings with basements (other than very small basements), stairways serving upper floors should preferably not extend to the basement and in any case should not do so where they are the only stairway serving the upper floors. Any stairway that extends from the basement to the upper floors should be separated at basement level by a fire-resisting lobby or corridor between the basement and the stairway. All basements used by more than 60 people or where there are no exits directly to a place of total safety should have at least two protected escape stairways.

In high-risk premises there should be an alternative stairway from the basement to ground level, unless there is a suitable alternative route to the final exit.

Wherever possible all stairways to basements should be entered at ground level from the open air, and should be positioned so that smoke from any fire in the basement would not obstruct any exit serving the other floors of the building.

Where any stairway links a basement with the ground floor, the basement should be separated from the ground floor, preferably by two 30-minute fire doors, one at basement and one at ground floor level (see Figure 39).

As a minimum, any floor over a basement should provide 60 minutes' fire resistance. For smaller premises, 30 minutes may be acceptable. Where this is impractical, and as long as no smoke can get through the floor, automatic smoke detection linked to a fire-alarm system which is audible throughout the premises could, as an alternative, be provided in the basement area. If in doubt, contact a competent person for more detailed advice.

Figure 38: Dead-end condition provided with an alternative exit

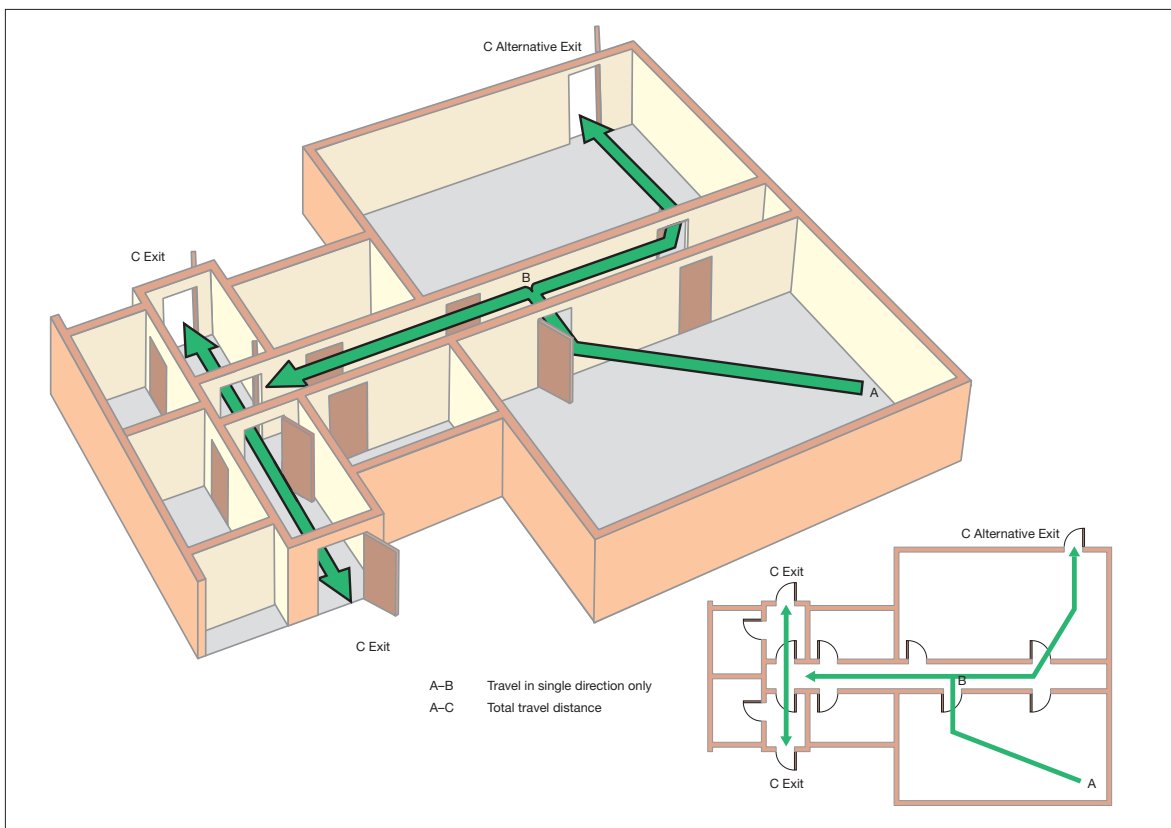
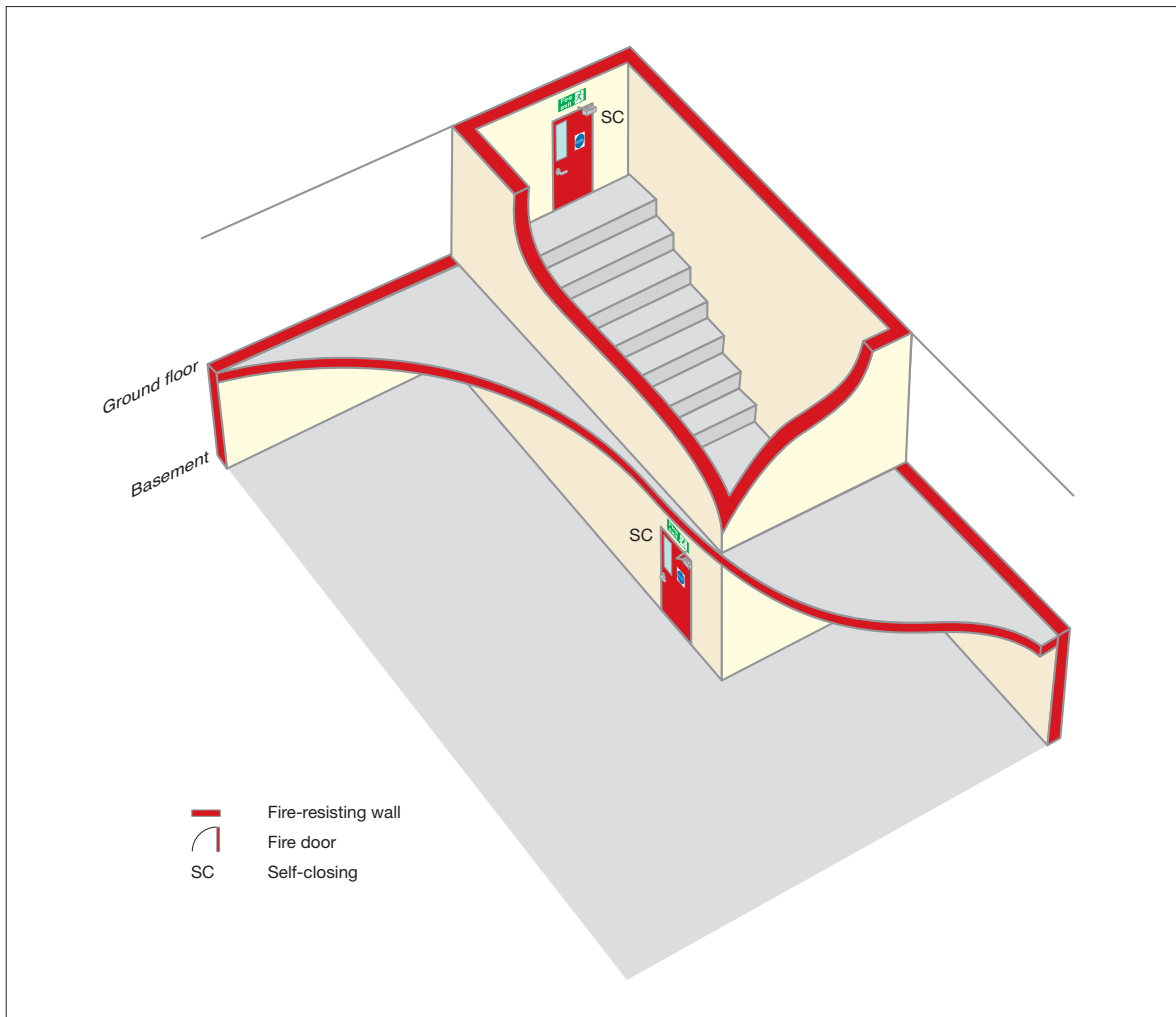

Figure 39: Basement protection



Subdivision of corridors

If your premises has corridors more than 30m long, then generally these corridors should be subdivided near the centre of the corridor with fire doors and, where necessary, fire-resisting construction to limit the spread of fire and smoke and to protect escape routes if there is a fire.

Where a corridor serves two exits from a floor, generally these corridors should be subdivided with fire doors to separate the two exits (see Figure 40).

Doors that are provided solely for the purpose of restricting the travel of smoke need not be fire doors, but will be suitable as long as they are of substantial construction, are capable of resisting the passage of smoke, and are self-closing. Smoke should not be able to bypass these doors, e.g. above a false ceiling, or via alternative doors from a room, or adjoining rooms, opening on either side of the subdivision.

Generally, false ceilings should be provided with barriers or smoke stopping over any fire doors. Where the false ceiling forms part of the fire-resisting construction this may not be necessary.

If you have doubts about subdivision of corridors, ask advice from a competent person.

Figure 40: Subdivision of corridor between two stairways or exits

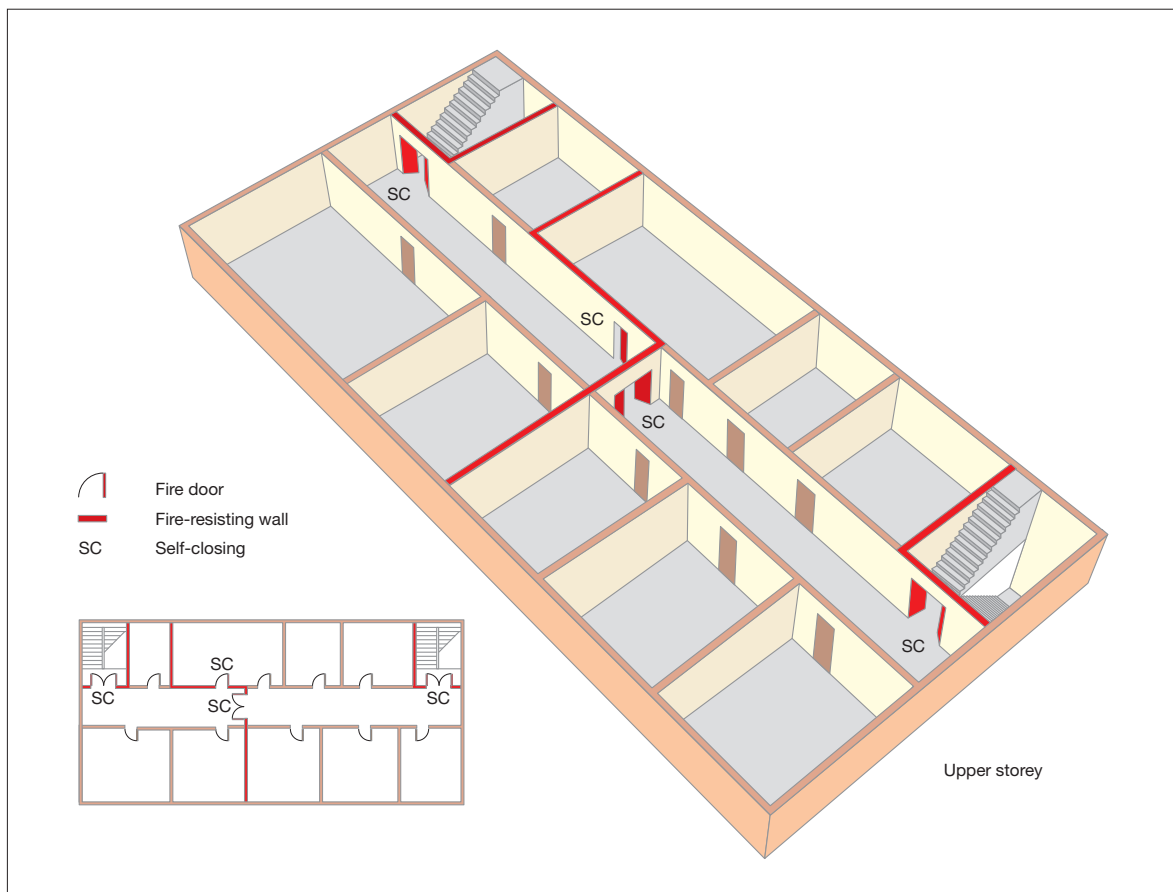

Stairway enclosures

Stairways, if unprotected from fire, can rapidly become affected by heat and smoke, cutting off the escape route and allowing fire spread to other floors. However, if adequately protected, escape stairways can be regarded as places of reasonable safety to enable people to escape to a place of total safety.

In most premises designed and built to building regulations and served by more than one stairway, it is probable that these stairways will be protected by fire-resisting construction and will lead to a final exit. If any floor has an occupancy of over 60, each storey should have at least two exits, i.e. protected routes. The figure of 60 can be varied in proportion to the risk: lower risk slight increase, higher risk lower numbers of persons.

It is possible that you may have some stairways which have no fire protection to them. In this case they are not designed for escape and are normally known as accommodation stairways (see accommodation stairways on page 91).

If you have a protected stairway(s) then it is essential that you maintain that level of fire protection.

The benefit of protecting stairways from the effects of fire allows you to measure your travel distance from the furthest point on the relevant floor to the nearest storey exit rather than the final exit of the building.

If you do not have a protected stairway, depending on the outcome of your fire risk assessment, it may be that you can achieve an equivalent level of safety by other means. However, before doing so you should seek advice from a competent person.

If the building you occupy has floors which are occupied by different organisations to your own, you need to consider, as part of your fire risk assessment, the possibility that a fire may occur in another part of the building over which you may have no control and which may affect the protected stairway if allowed to develop unchecked. If your fire risk assessment shows that this may be the case and people using any floor would be unaware of a developing fire, then additional fire-protection measures may be required, e.g. an automatic fire-detection and warning system. If this is required you will need to consult and co-operate with other occupiers and building managers.

You may find that stairways in your building are provided with protected lobbies or corridors at each floor level, except the top floor (see Figure 41). Although these are not generally necessary for means of escape in multi-stairway buildings of less than 18m high, they may have been provided for other reasons (e.g. firefighting access). In all cases protected corridors, lobbies and stairways must be kept clear of combustibles and obstructions.

Ideally stairway enclosures should lead directly to a final exit. If your premises has only one stairway from the upper floor(s) which does not lead directly to a final exit, adopt one of the following arrangements:

- provide a protected route from the foot of the stairway enclosure leading to a final exit (see Figure 42); or
- provide two exits from the stairway, each giving access to a final exit via routes which are separated from each other by fire-resisting construction (see Figure 43).

Figure 41: Examples of a stairway with protected lobby/corridor approach

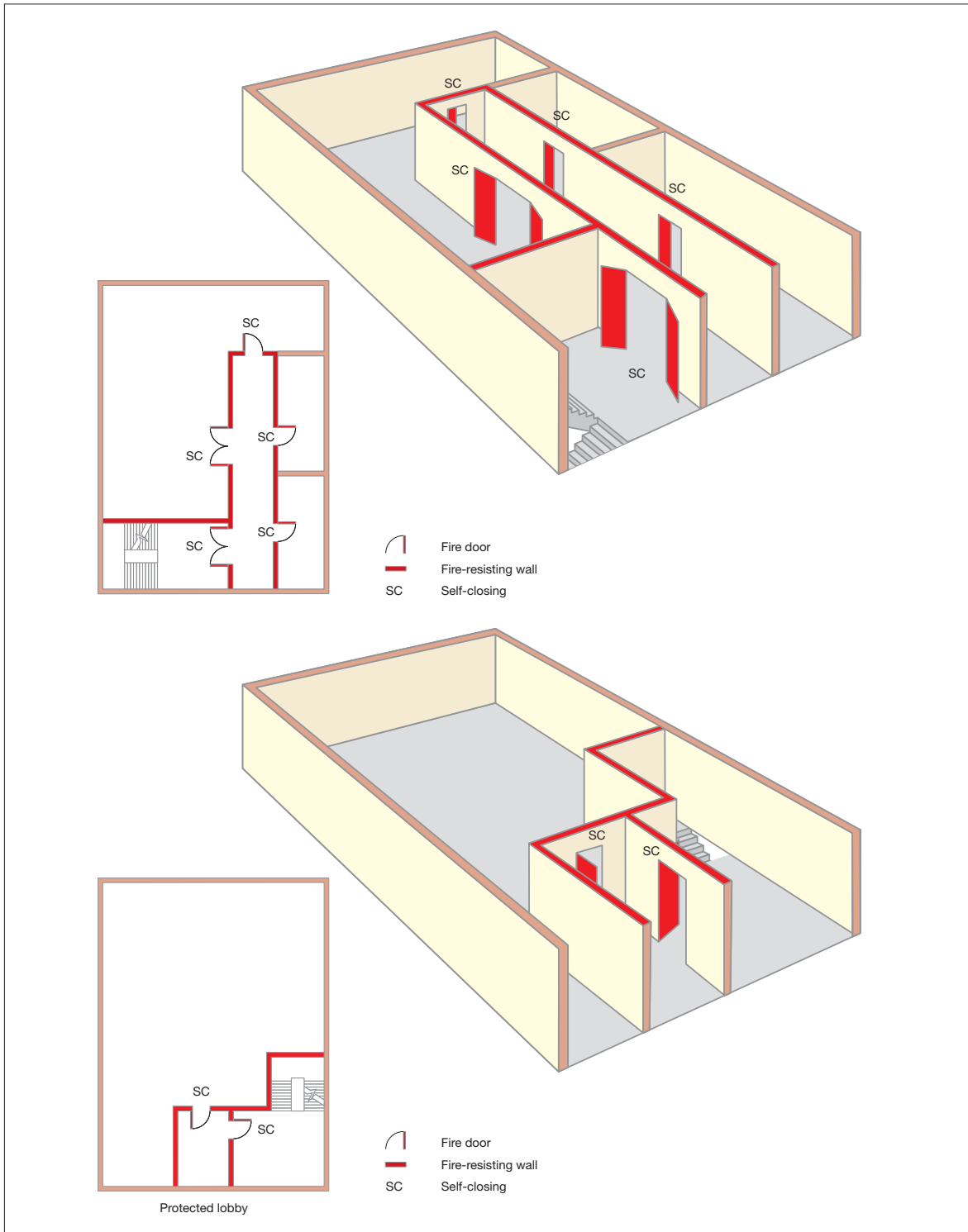

Figure 42: Examples of a protected route from a stairway to a final exit

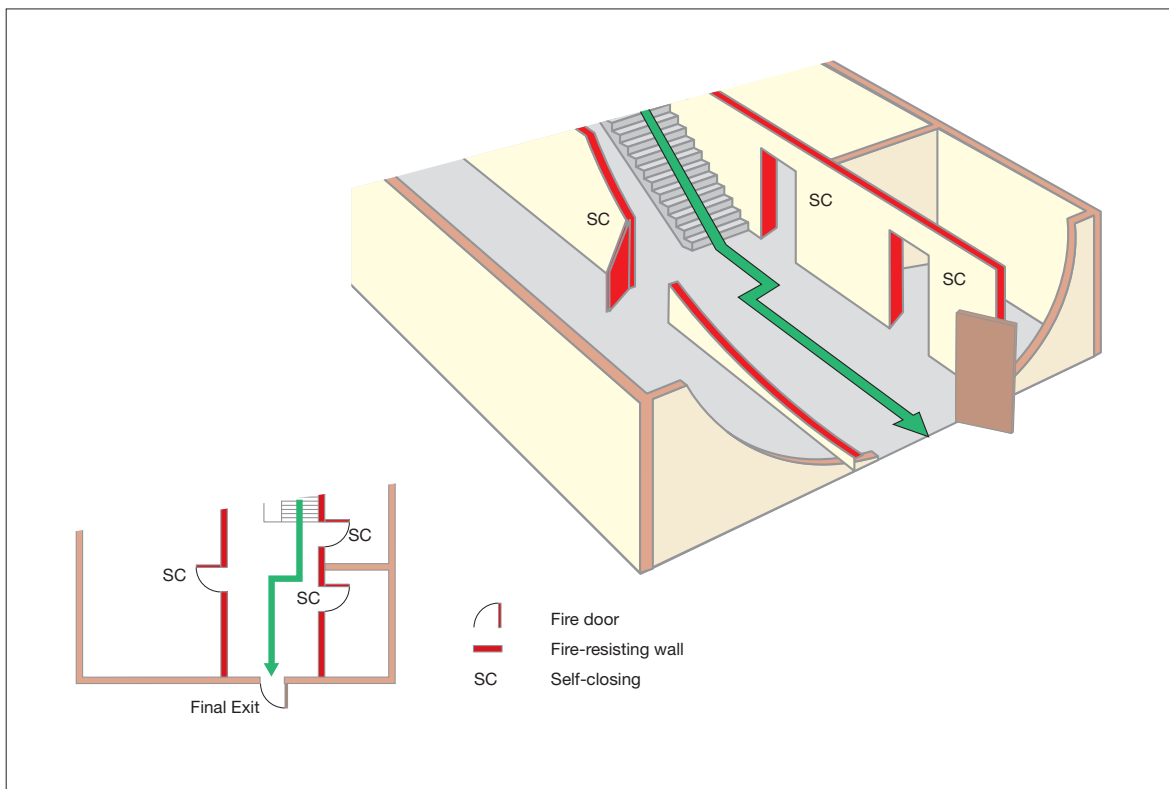
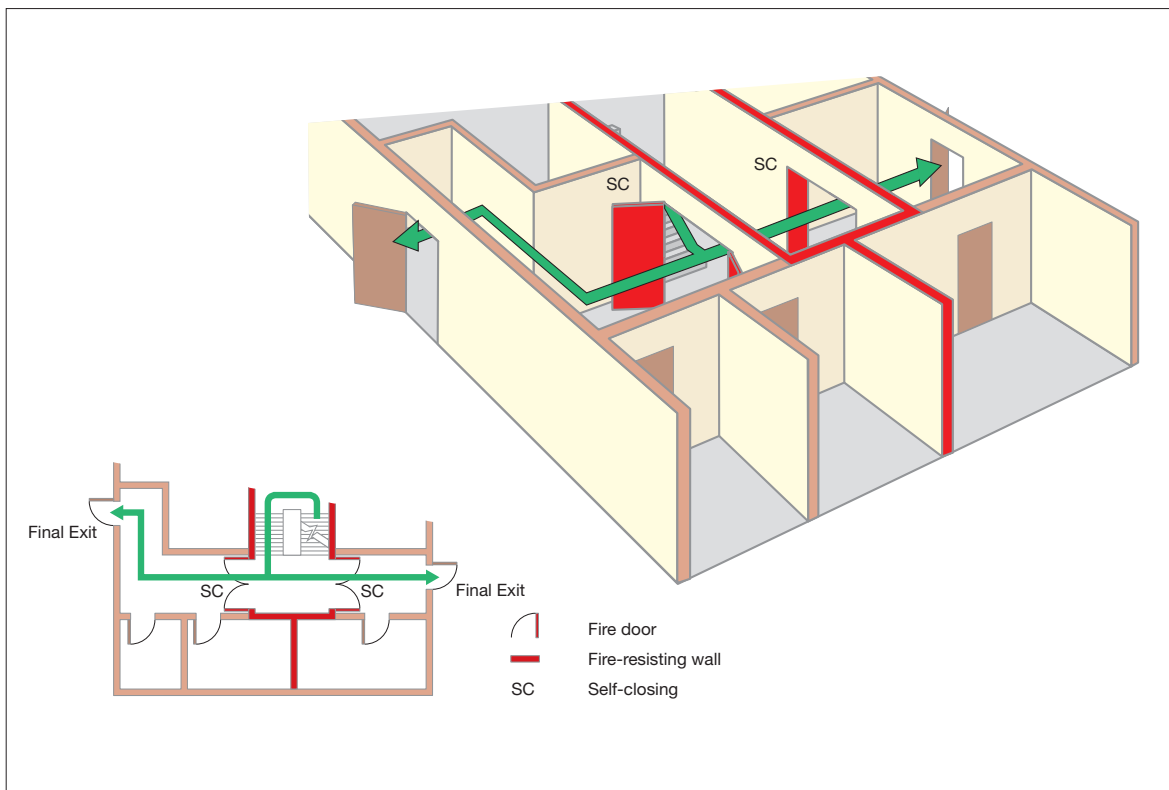

Figure 43: Example of two escape routes from a stairway to final exits



Separation of protected stairways

Where there are two or more protected stairways, the routes to final exits should be separated by fire-resisting construction so that fire cannot affect more than one escape route at the same time (see Figure 44).

Creating a stairway bypass route

No one should have to pass through a protected stairway to reach another stairway. Options to avoid this include:

- using intercommunicating doors between rooms adjacent to the stairway; such doors must be available at all times when the building is occupied (see Figure 45);
- using balconies and other features to bypass the stairway; or
- as long as there is enough space, create a bypass corridor around the stairway enclosure.

Figure 44: Separation of protected stairways

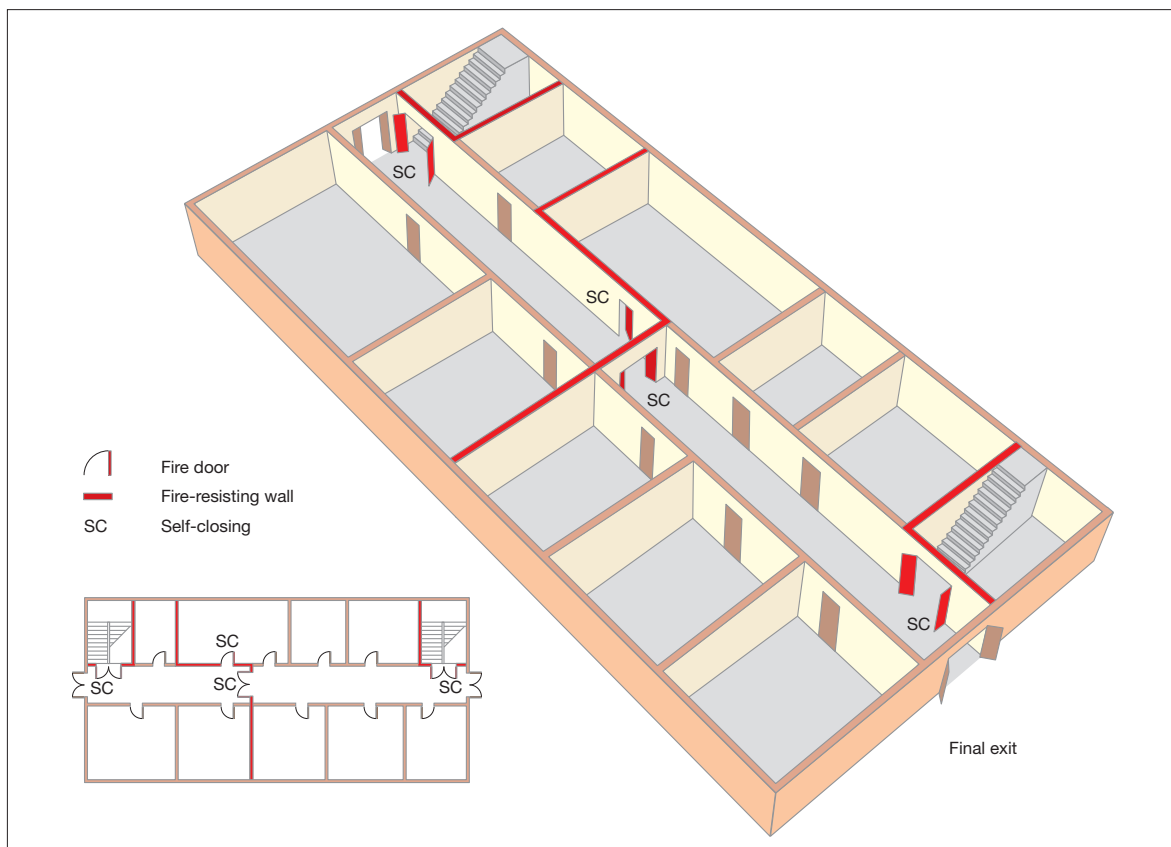

Reception areas

Reception or enquiry areas should only be located in protected stairways where the stairway is not the only one serving the upper floors, the reception area is small (less than 10m²) and is of low fire risk.

Accommodation stairways

If you have stairways that are used for general communication and movement of people in the premises, and they are not designated as fire escape stairs, then these are called ‘accommodation stairways’. They may not require fire separation from the remainder of

the floor as long as they do not pass through a compartment floor, or people do not have to pass the head of such a stairway in order to access a means of escape stairway. However, experience shows that many people will continue to use these as an escape route.

Accommodation stairways should not normally form an integral part of the calculated escape route; however, where your fire risk assessment indicates that it is safe to do so, then you may consider them for that purpose. In these cases it may be necessary to seek advice from a competent person to verify this.

Figure 45: A stairway bypass route

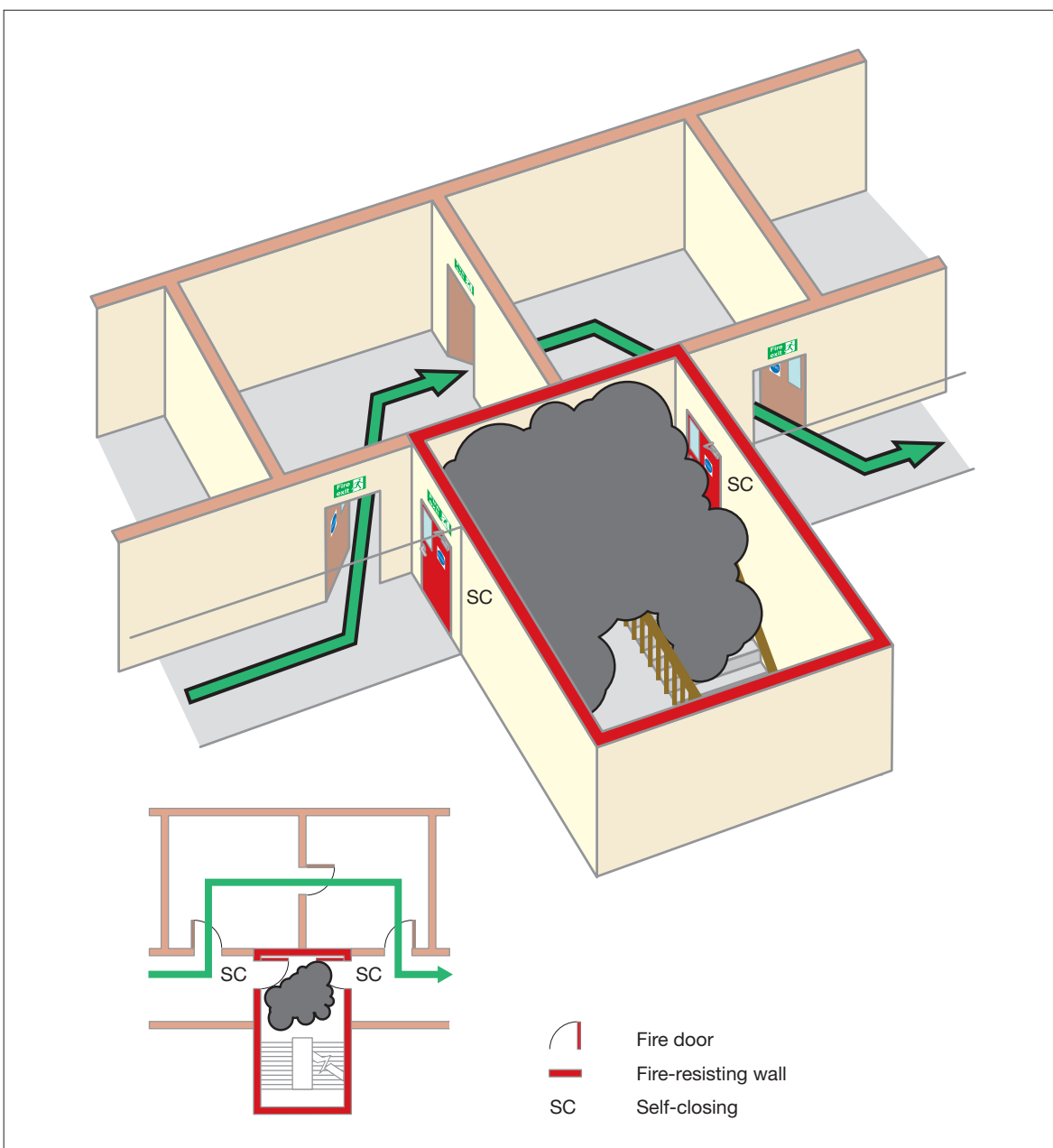

External stairways

To be considered a viable escape route, an external stairway should normally be protected from the effects of a fire along its full length. This means that any door, window (other than toilet windows) and walls within 1.8m horizontally and 9m vertically below any part of the stairway should be fire-resisting. Windows should be fixed shut and doors self-closing (see Figure 46).

Consider protecting the external stairway from the weather as the treads may become slippery, e.g. due to algae, moss or ice. If this is not possible, you must ensure that the stairway is regularly maintained. Consider fixing non-slip material to the treads.

External stairways should not normally be used for members of the public, particularly where large numbers are likely to use them.

Figure 46: Protection to an external stairway

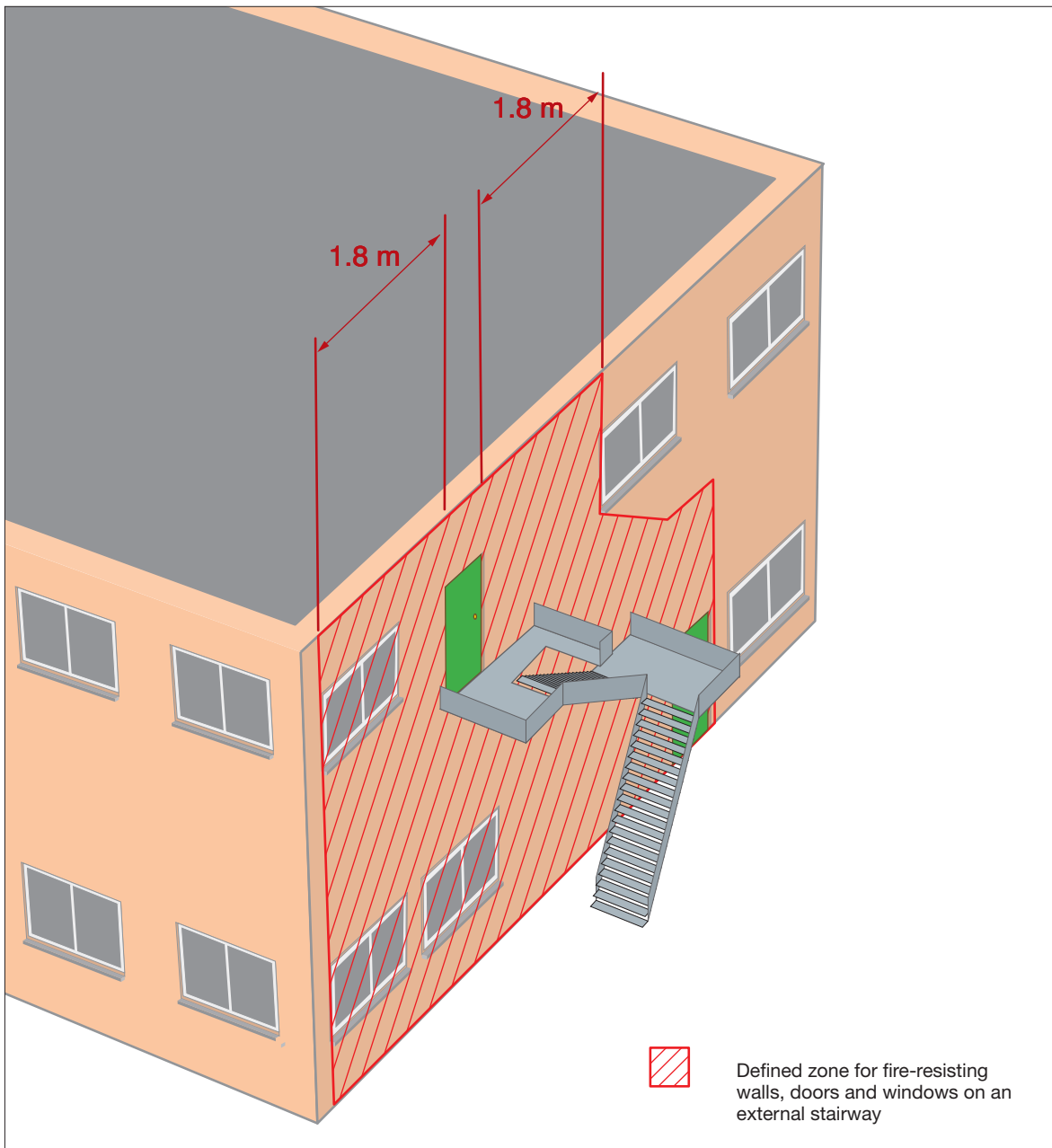

Spiral and helical stairways

Spiral and helical stairways are usually acceptable only in exceptional situations, e.g. for a maximum of 50 people who are not members of the public. The stairway should not be more than 9m in total height and not less than 1.5m in diameter with adequate headroom. A handrail should be continuous throughout the full length of the stairway.

However, spiral and helical stairways may be used as means of escape by more than 50 staff and may be used by the public if the stairways have been designed for that purpose. Further guidance is given in BS 5395-2⁷⁵ including about type E (public) stairs under that standard.

Lifts

Due to the danger of the power supplies to a lift being affected by a fire, lifts not specifically designed as 'fire fighting' or 'evacuation' lifts are not normally considered acceptable as a means of escape. However, where a lift and stairway for a means of escape are incorporated in a fire-resisting shaft which has a final exit from it at the access level and the lift has a separate electrical supply to that of the remainder of the building, then that lift, subject to an agreed fire risk assessment, may be acceptable as a means of escape in case of fire.

Lifts are housed in vertical shafts that interconnect floors and compartments, therefore precautions have to be taken to protect people from the risk of fire and smoke spreading from floor to floor via the lift shaft. Such precautions may include:

- separating the lift from the remainder of the storey using fire-resisting construction and access via a fire door;
- ensuring the lift shaft is situated in a protected enclosure which may also be a stairway enclosure; and
- providing ventilation of at least 0.1m² at the top of each lift well to exhaust any smoke.

Upward escape

Other than from a basement, people should not normally have to ascend more than one level to escape (e.g. from the top floor to use a roof exit). The upper level should not be an area of high fire risk.

Escalators and travelators

Escalators provide the most effective mode of transport where there is a necessity to move large numbers of people between different levels.

Where escalators are used to provide the means of escape from a sub-surface station, for example, the escalators are operated under management control (i.e. the escalators do not stop on activation of the fire alarm, but will be stopped – or reversed – under manual control if deemed necessary).

Where escalators and travelators are not the principle means of escape, but may work to aid the movement of people away from an area of risk, a slightly different approach can be used. In such cases, the escalators/travelators may be interfaced with the fire alarm. For example:

- a travelator/escalator moving towards a zone in alarm will soft stop automatically; and
- a travelator/escalator moving away from a zone in alarm will continue to run.

This approach has been shown to aid management of the safe evacuation of passengers. If escalators are used as a means of escape and are located within circulation routes, they should be suitably constructed and protected to ensure that they do not present a fire hazard themselves and can continue to operate in an emergency.

Portable ladders and throw-out ladders

Throw-out ladders are not acceptable as a means of escape in large premises. Portable ladders are only acceptable in exceptional circumstances where it will be reasonable for ladders of this kind to provide escape for one or two able-bodied staff (e.g. from a high-level plant room).

Fixed vertical or raking ladders

These are normally only suitable for use by a limited number of able-bodied staff where they form the only means of access to plant spaces, provided they are suitably guarded and the total descent does not exceed 9m without an intermediate landing. Where they are external, they should be protected from the elements in the same way as external stairways.

Lowering lines and other self-rescue devices

These are not acceptable as a means of escape from large premises.

Roof exits

It may be reasonable for an escape route to cross a roof. Where this is the case, additional precautions will normally be necessary:

- The roof should be flat and the route across it should be adequately defined and well-illuminated where necessary with normal electric and emergency escape lighting. The route should be non-slip and guarded with a protective barrier.
- The escape route across the roof and its supporting structure should be constructed as a fire-resisting floor.
- Where there are no alternatives other than to use a roof exit, any doors, windows, roof lights and ducting within 3m of the escape route should be fire-resisting.
- The exit from the roof should be in, or lead to, a place of reasonable safety where people can quickly move to a place of total safety.

- Where an escape route passes through or across another person's property, you will need to have a robust legal agreement in place to allow its use at all times when people are on your premises.
- These routes should not normally be used by members of the public.

A typical escape route across a roof is illustrated in Figure 47.

External escape routes should receive routine inspection and maintenance to ensure they remain fit for use.

If your premises are part of a multi-occupied building, you will need to liaise with the owner or other persons responsible for the building. You will need to ensure that any legal agreements in place cover access for maintenance of the escape route.

Figure 47: An escape route across a roof

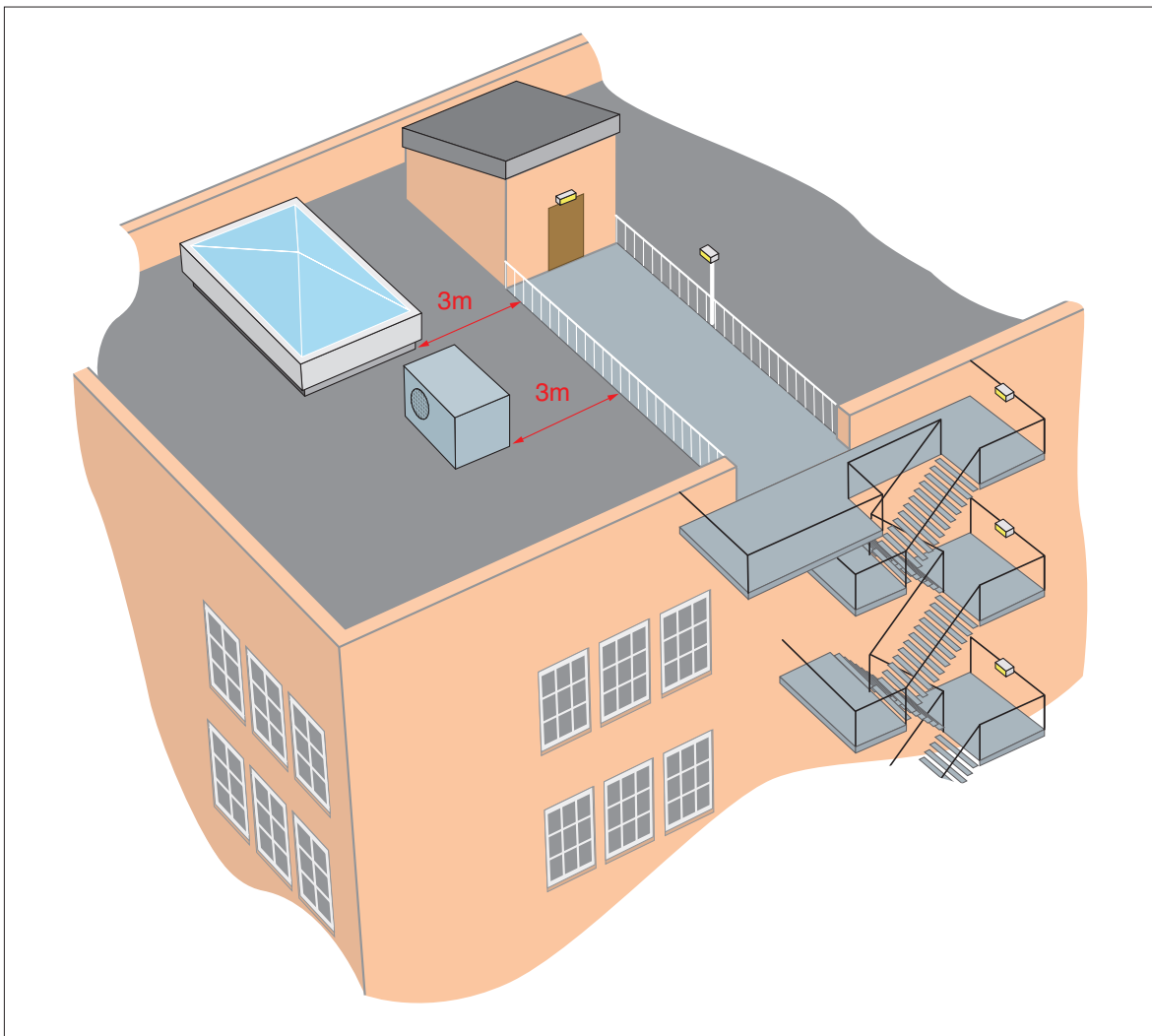

Revolving doors, turnstiles and sliding doors

Revolving doors should not normally be considered as escape doors unless the leaves fold outward to form a clear opening upon pressure from within, or standard doors of the required exit width are provided next to the revolving door.

Ideally, revolving doors should have a bypass door adjacent to them for use as an escape route. The exit width should be appropriate for the escape route it serves.

Where automatic sliding doors are used on an escape route, they should operate when used in an evacuation so that they do not impede the evacuation, and, in the event of a power failure, fail safe in the open position. Alternatively, they can be provided with a monitored failsafe system for opening the doors if the power supply fails. The same principles apply to turnstiles.

Manual sliding doors are not normally suitable on escape routes unless they are for the sole use of members of staff. Where provided, a notice with the words 'slide to open', with an arrow pointing in the direction of opening, should be permanently displayed at about eye level on the face of the doors.

Wicket doors and roller shutters

Wicket doors or gates should have a minimum opening height of 1.5m. The bottom of the door should not be more than 250mm above the floor and the width should be preferably more than 500mm but not less than 450mm. Normally wicket doors will only be suitable for up to 15 members of staff; however, in areas of a higher fire risk, this should be reduced to a maximum of three.

Loading and goods delivery doors, shutters (roller, folding or sliding), up-and-over doors and similar openings are not normally suitable for use as a final exit. However, they may be suitable for escape from areas of normal risk by small numbers of staff as long as they are not likely to be obstructed and can be easily and immediately opened manually, even if normally power-operated, and staff are familiar with the escape routes.

Fastenings on doors

You should ensure that any exit door or gate which is required to be kept open while the public are on the premises should be provided with appropriate fastenings so that the door or gate is kept open in such a way that it will not cause an obstruction. Appropriate fastenings for the public are push bars and push pads;

handles requiring a turning action, for example, should not be used on doors for the public (see BS EN 1125⁷² and BS EN 179⁷³).

Doors used for means of escape should be kept unlocked at all times when people are in the premises and in no case should a door be fastened so that it cannot easily and immediately be opened from the inside without the use of a key. If the door has to be kept fastened while persons are in the building, the fastening should be by means of a panic latch or panic bar (or similar) so that the door can be readily opened by pressure applied by persons within.

For structural reasons some doors may not open in the direction of the exit. These, and all collapsible, sliding or roller gates or shutters, should be locked (with a removable key) in the fully open position, at all times when the public are present. During such times, you should remove the key and keep it secure (e.g. in a manager's office).

If you have doors, gates, or shutters which need to be locked open, a notice or notices clearly visible on both sides of the door, gate or shutter (whether open or closed) should be prominently displayed. The notice should bear the words 'This door (gate, shutter, etc.) to be secured open when the premises are occupied'.

You should ensure that security fastenings such as chains, bars, padlocks, etc. are removed from all doors, gates, shutters, etc. on exit routes at all times the public are in the premises prior to the building being put to use.

No removable fastening should be replaced until the public have left the premises and sufficient exits should remain available for staff who may be present.

Final exit doors and escape away from the premises

Good escape routes to a final exit will be of little benefit if the occupants are not able to get out of the building and quickly disperse from the area to a place of total safety. It is also important to consider where people will go once they have evacuated from the premises.

The matters that you should consider include the following:

- Final exit doors should be quickly and easily openable without a key or code in the event of a fire. Where possible, there should be only one fastening. See Appendix B3 for more information on security fastenings.

- Where a final exit discharges into an enclosed area, further access to a place of total safety should be made available under management control.

Childcare facilities/crèches

The location of childcare facilities/crèches in your premises is important since parents or guardians will often seek to return to the facility when the alarm sounds. It is therefore important that the facility is located so as to avoid parents travelling against the normal direction of escape. The childcare facility should be sited at the same level as the parents or guardians or on the route to the final exit.

4.2 Escape route layout

The examples listed in Table 3 show typical escape route solutions for a range of common building layouts. In each case the solution is for a normal risk building unless otherwise illustrated.

These are not intended to be prescriptive or exhaustive but merely to help you understand how the principles of means of escape may be applied in practice.

They are illustrative of the key features of escape route layouts and not intended to be real building layouts or to scale.

You do not need to read all of this section, you only need to consider those figures and the accompanying text which most closely resemble your premises. If your premises do not resemble these then you should seek advice from a competent person. These examples do not include any examples of concourse or platform layouts. If the escape distances from these areas exceed the distances in Table 2, you are advised to seek the guidance of a competent person. These examples are intended to represent your existing layout; they are not to be used as design guidance.

In all of these examples the following basic principles apply:

- The furthest point on any floor to the final exit or storey exit to a protected stairway is within the overall suggested travel distance (see Table 2 on page 78).
- The route to and the area near the exit is kept clear of combustibles and obstructions.
- The fire-resisting stairway is kept clear of combustibles and obstructions.
- The escape route leads to a final exit.
- Where the stairway is not a protected stairway, the final exit is visible and accessible from the discharge point of the stairway at ground floor level.
- High-risk rooms do not generally open directly into a protected stairway.
- If your fire risk assessment shows that people using any floor would be unaware of a fire, you may require additional fire-protection measures, e.g. an automatic fire-detection and warning system.
- There should be more than one escape route from all parts of the premises (rooms or storeys) except for areas or storeys with an occupancy of less than 60. The figure of 60 can be varied in proportion to the risk: for a lower risk there can be a slight increase, for a higher risk, lower numbers of persons should be allowed.

Table 3: Typical examples of escape route layouts

Single-storey buildings or the ground floor of a larger building	
Ground floor with more than one exit	See Figure 48
Ground floor with more than one exit	See Figure 49
Ground floor with a single exit (including a mezzanine) (as part of larger premises)	See Figure 50
Multi-storey buildings with more than one stairway	
Two-storey premises: lower risk premises	See Figure 51
Two-storey premises: higher risk premises	See Figure 52
Three-storey premises: basement, ground and one upper floor	See Figure 53
Four-storey premises: ground and up to three upper floors	See Figure 54
Tall building with a firefighting shaft	See Figure 55
Multi-storey buildings with a single stairway	
Two-storey premises: ground and one upper floor	See Figure 56
Two-storey premises: basement and ground floor	See Figure 57
Three-storey premises: small basement, ground and one upper floor	See Figure 58
Three-storey premises: basement, ground and one upper floor	See Figure 59
Four-storey premises: ground and up to three upper floors – protected by lobbies/corridors	See Figure 60
Four-storey premises: ground and up to three upper floors – protected with automatic fire detection	See Figure 61

If you do not have any of the stairway configurations given, and depending on the outcome of your fire risk assessment, it may be that you can achieve an equivalent level of safety by other means.

The green arrows on Figures 50–61 represent the travel distances given in Table 2 (page 78) which should be applied.

If your building has more than ground and three upper storeys, ask advice from a competent person.

Single-storey buildings (or the ground floor of a larger building)

Ground floor premises with more than one exit

Figures 48 and 49 show acceptable examples of a ground floor cellular layout with more than one exit in smaller and larger premises respectively.

Figure 48: Ground floor premises with more than one exit

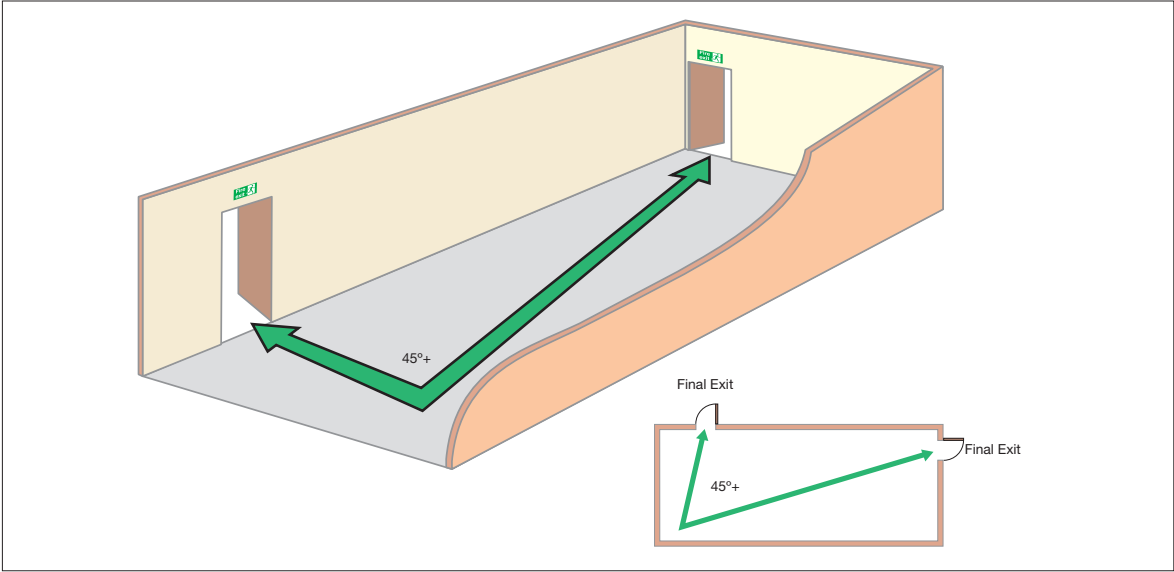
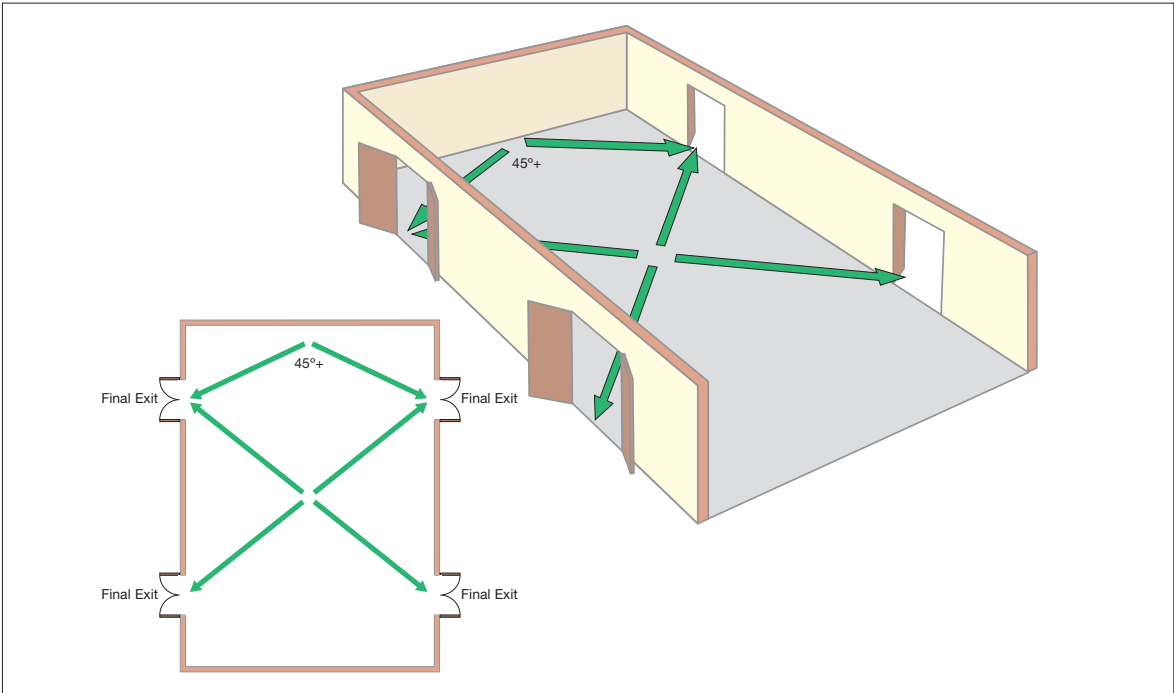

Figure 49: Ground floor premises with more than one exit



Ground floor premises with a single exit (including a mezzanine) (as part of larger premises)

Part of your premises may have only a single exit. The example shown in Figure 50 will be generally acceptable provided that the part of the premises served by only a single exit (i.e. ground floor and mezzanine) accommodates no more than 60 people in total.

If your fire risk assessment shows that people using the mezzanine would be unaware of a fire, it may require additional fire-protection measures, e.g. an automatic fire-detection and warning system.

Note: A mezzanine covering more than half of the floor area may need to be treated as a separate floor (see two-storey buildings).

Figure 50: Ground floor premises with a single exit (including a mezzanine) (as part of larger premises)

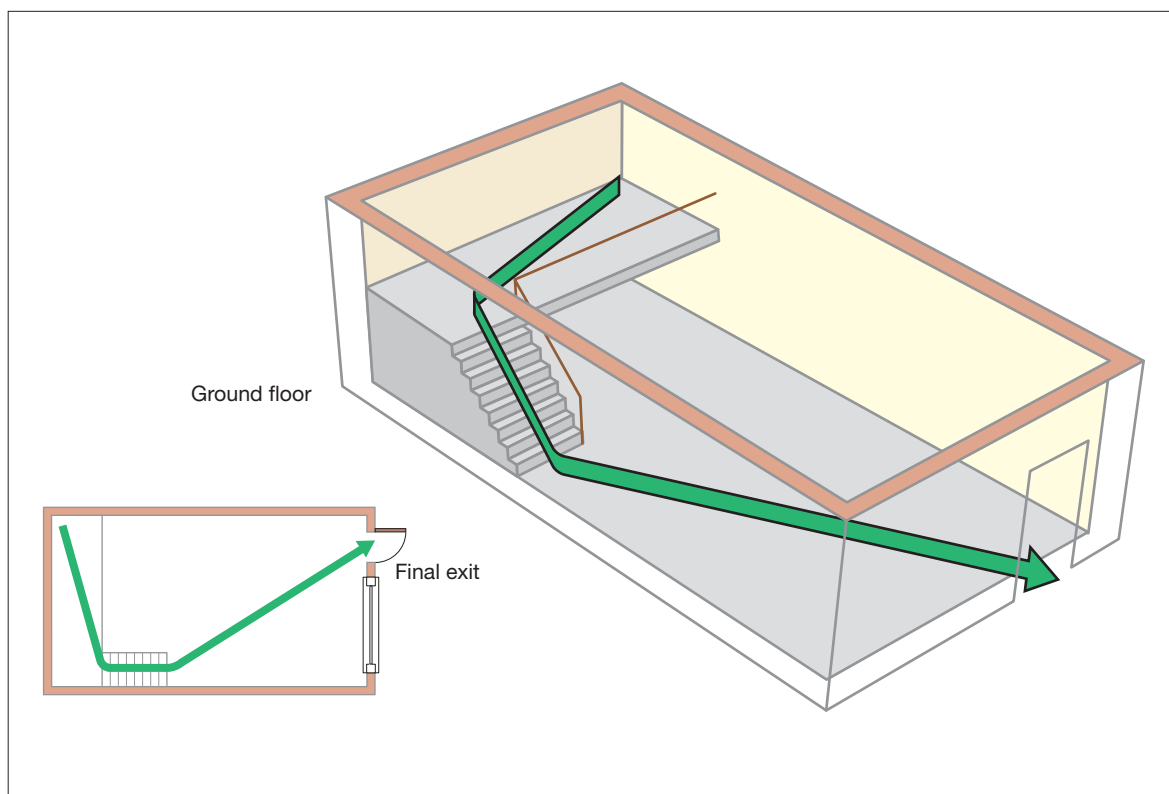

Multi-storey buildings with more than one stairway

Two-storey premises

If your premises has a ground floor and one upper floor and these are served by more than one stairway, it is important to understand that you may not be able to meet the suggested travel distance to a final exit (see Table 2 on page 78). In this case, stairways may therefore need to be protected by a fire-resisting enclosure as shown.

The layout shown in Figures 51 and 52 will be generally acceptable as long as the furthest point on each of your floors to the storey exit (or to a final exit using an unprotected stair) is within the overall suggested travel distance (see Table 2 on page 78).

This principle applies to taller buildings (up to 18m). However, where your building has more than three upper storeys ask advice from a competent person.

Figure 51: Two-storey premises: lower risk premises

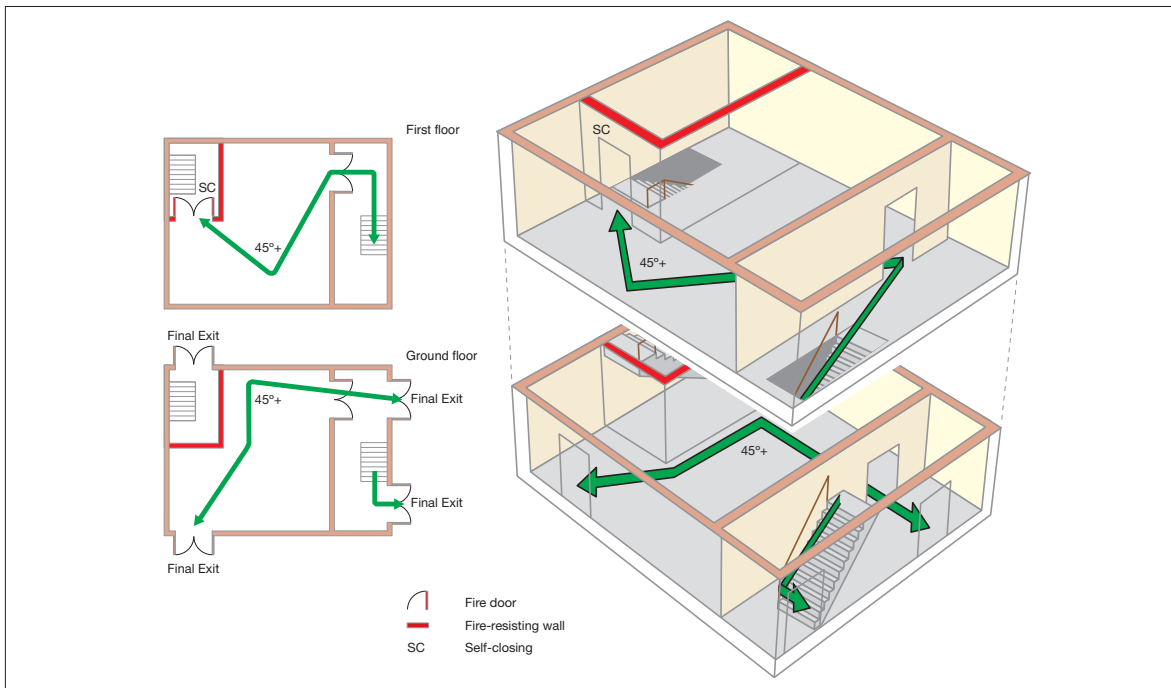
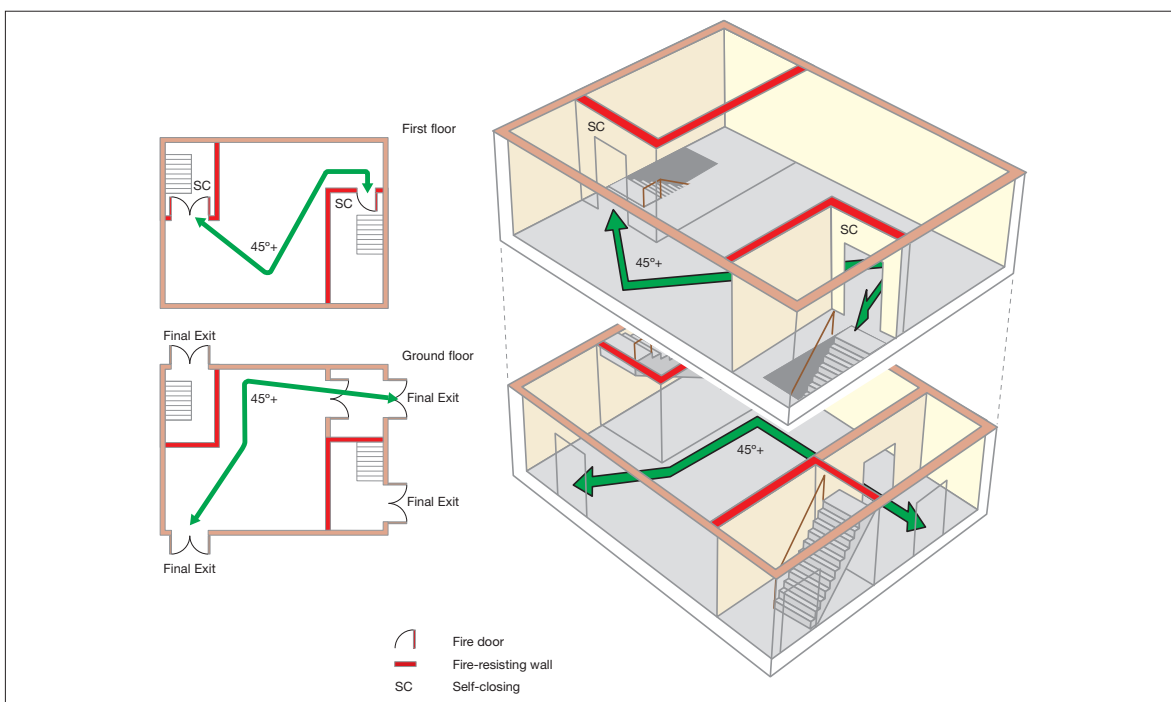

Figure 52: Two-storey premises: higher risk premises



Three-storey premises: basement, ground and one upper floor

In premises with a basement, ground and first floor, served by more than one stairway, the layout shown in Figure 53 will be generally acceptable as long as the following apply:

- To overcome the restriction of travel distance the stairways have been completely enclosed in 30-minute fire-resisting construction and all doors onto the stairways are self-closing fire doors.
- The furthest point on each floor to the nearest storey exit is within the overall

suggested travel distance (see Table 2 on page 78).

- Where the building incorporates a basement, any stairway from the basement is separated by a fire-resisting lobby or corridor between the basement and the protected stairway.
- If the basement is served by only a single stairway, it should accommodate no more than 60 people. This principle applies to taller buildings (up to 18m). However, where your building has more than three storeys, ask advice from a competent person.

Figure 53: Three-storey premises: basement, ground and one upper floor

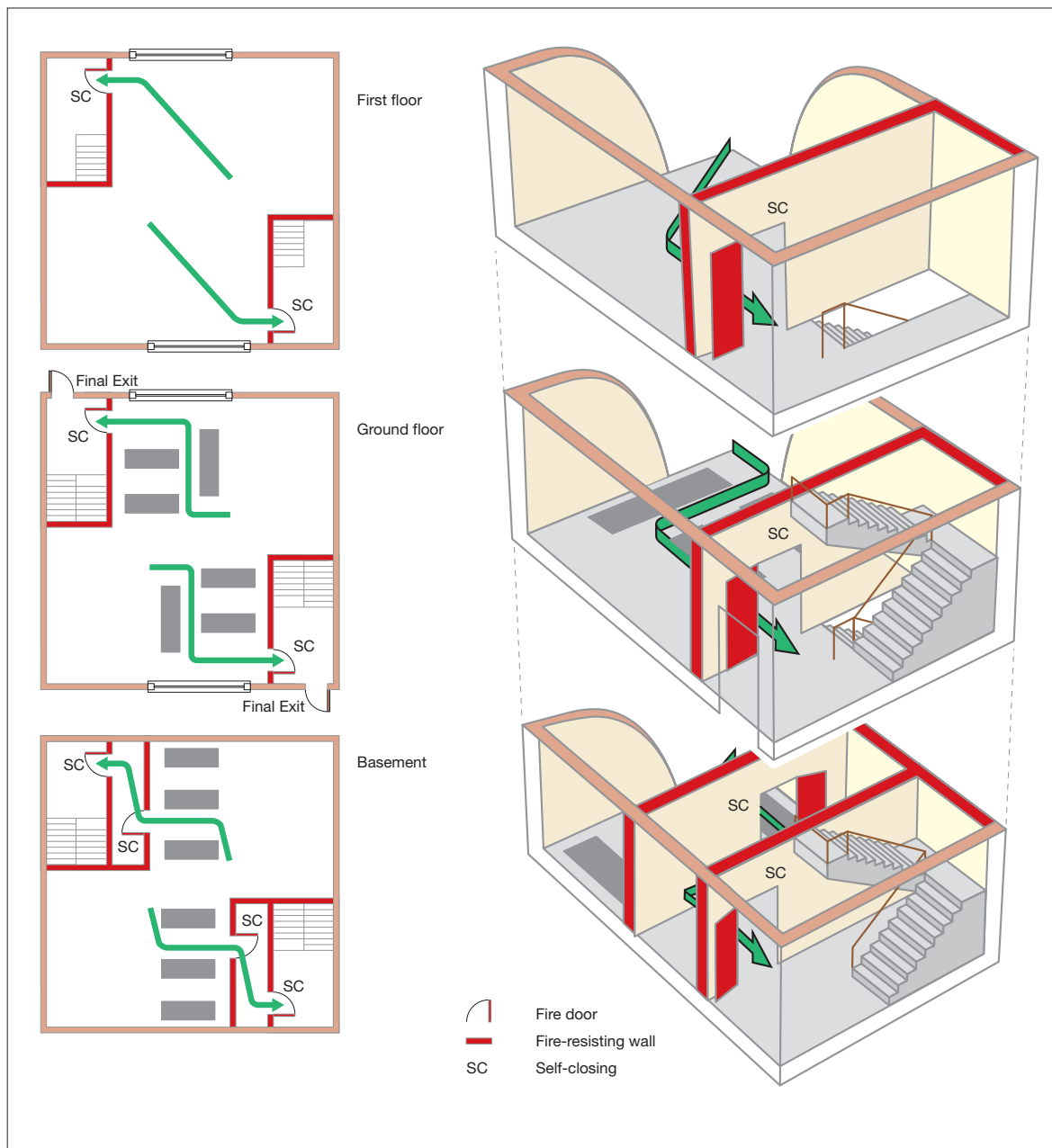

Four-storey premises: ground and up to three upper floors

If your premises have a ground floor and up to three upper floors served by more than one stairway, it is important to understand that you are unlikely to be able to meet the suggested travel distance to a final exit (see Table 2 on page 78). In these circumstances it is necessary to protect the stairway by a fire-resisting enclosure as shown.

The layout shown in Figure 54 will be generally acceptable as long as the furthest point on each floor to the storey exit is within the overall suggested travel distance (see Table 2 on page 78). This principle applies to taller buildings (up to 18m). However, where your building has more than three upper storeys, ask advice from a competent person.

Figure 54: Four-storey premises: ground and up to three upper floors

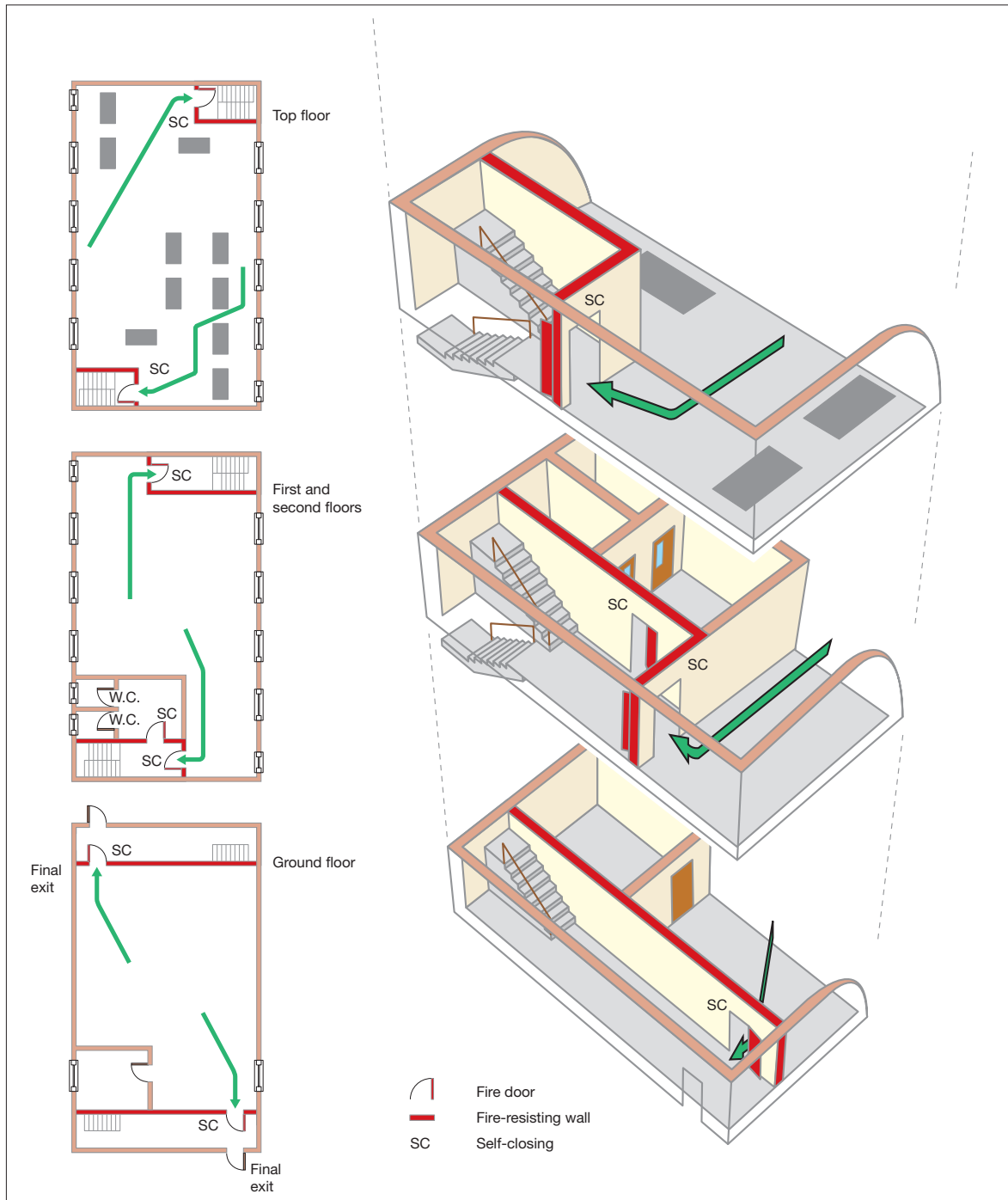

Tall building with a firefighting shaft

Figure 55 shows a multi-storey building more than 18m high fitted with a firefighting shaft which is required for specific types of buildings. If the premises you occupy are situated in a building like this, you should ask the advice of a competent person. Further information may be found in BS 5588-5⁷⁰ and Approved Document B.⁴⁶

Figure 55: Tall building with a firefighting shaft

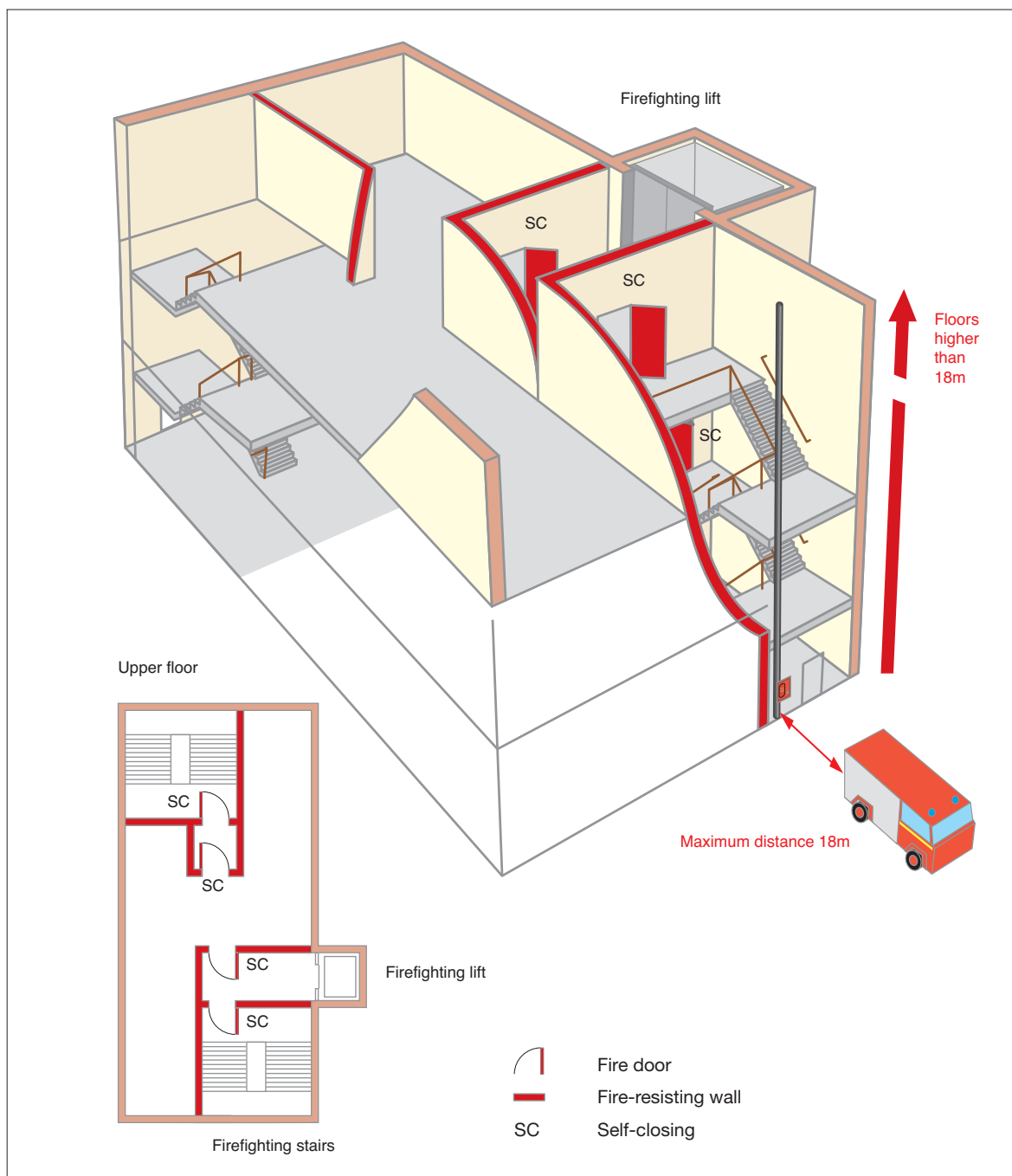

Multi-storey buildings with a single stairway

In general, multi-storey buildings used as transport facilities will be provided with two or more protected stairways. The single stairway examples provided in this section may be suitable for specific parts of a larger premises or building. If in doubt you should seek advice from a competent person.

Two-storey premises: ground and one upper floor

In premises with a ground floor and one upper storey with a single stairway and a simple layout, an open stairway is acceptable as indicated in Figure 56, provided that:

- The upper floor should accommodate no more than 60 people.
- The furthest point on each of the floors to the final exit is within the overall suggested travel distance for escape in one direction only (see Table 2 on page 78).

Figure 56: Two-storey premises: ground and one upper floor

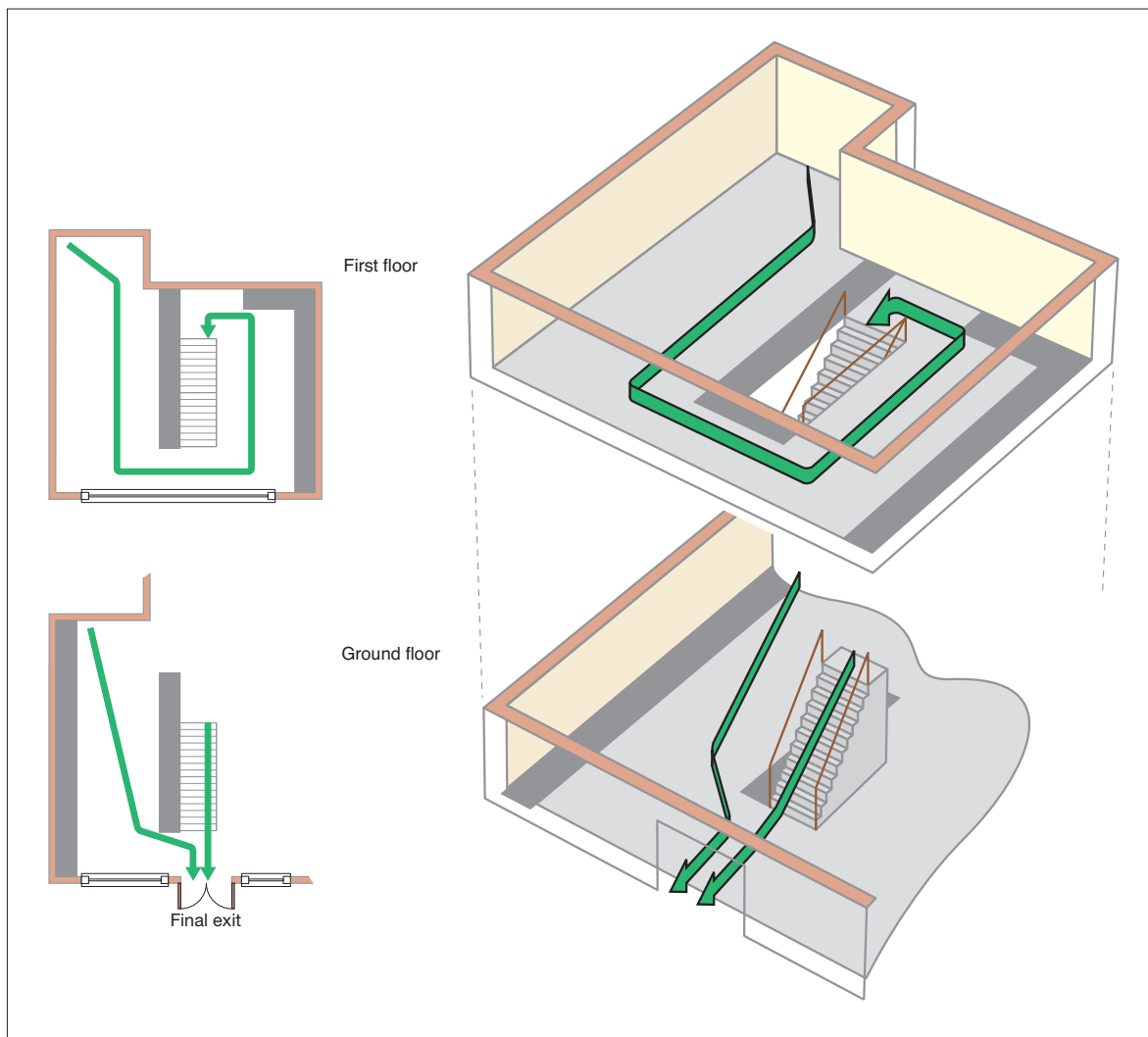

Two-storey premises: basement and ground floor

In premises with a basement and a simple layout, an open stairway is acceptable as indicated in Figure 57 provided:

- The basement can accommodate no more than 60 people.
- The furthest point on each floor to the final exit is within the overall suggested travel distance (see Table 2 on page 78).

Figure 57: Two-storey premises: basement and ground floor

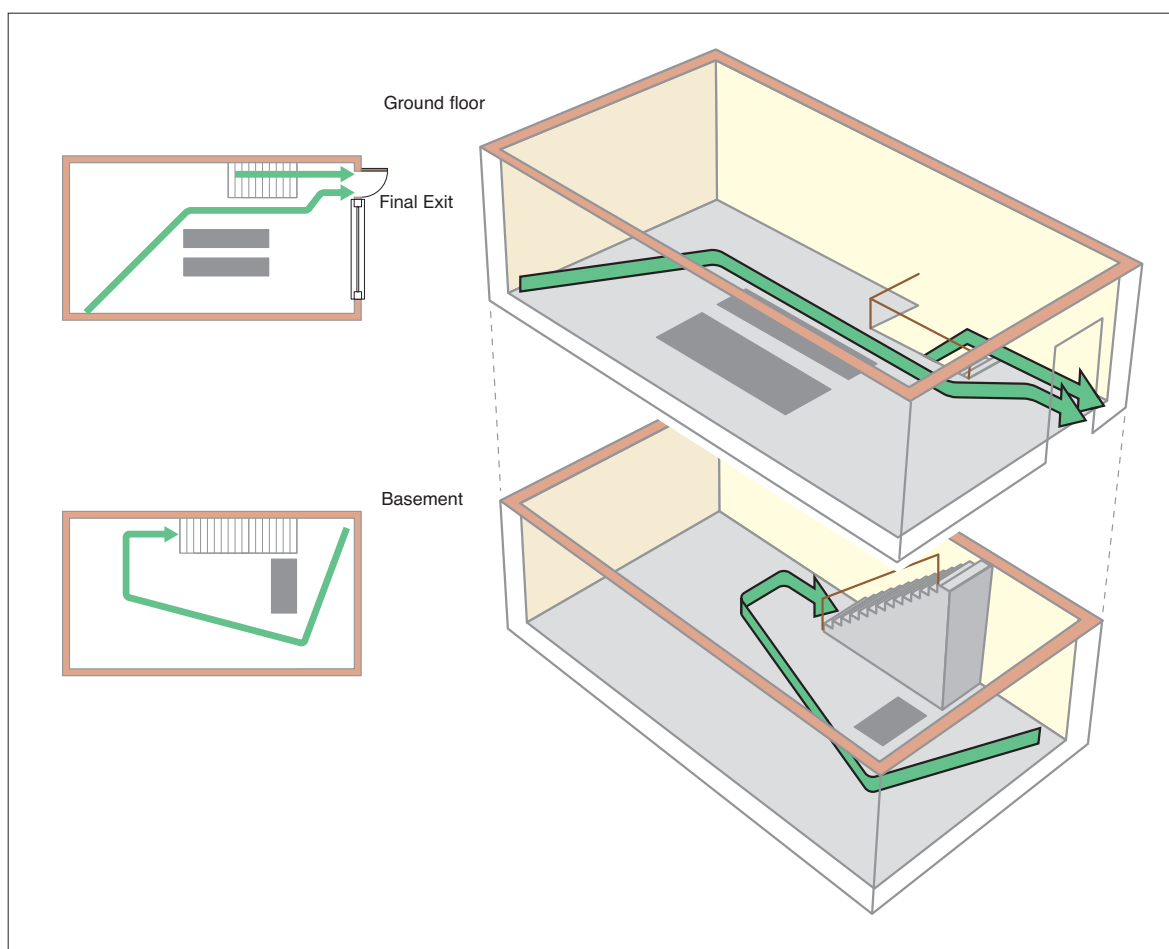

Three-storey premises: small basement, ground and one upper floor

In premises with a ground floor and a small basement and first floor, each served by a single stairway, the layout in Figure 58 will be generally acceptable as long as the following apply:

- The basement should accommodate no more than 60 people.
- The first floor should accommodate no more than 60 people.
- The furthest point in the basement to the door to the nearest stairway is within the overall suggested travel distance (see Table 2 on page 78).
- The stairway from the basement to ground floor level is enclosed by fire-resisting construction and leads to a final exit.
- The furthest point on the first floor to the **final** exit is within the overall suggested travel distance.

Figure 58: Three-storey premises: small basement, ground and one upper floor

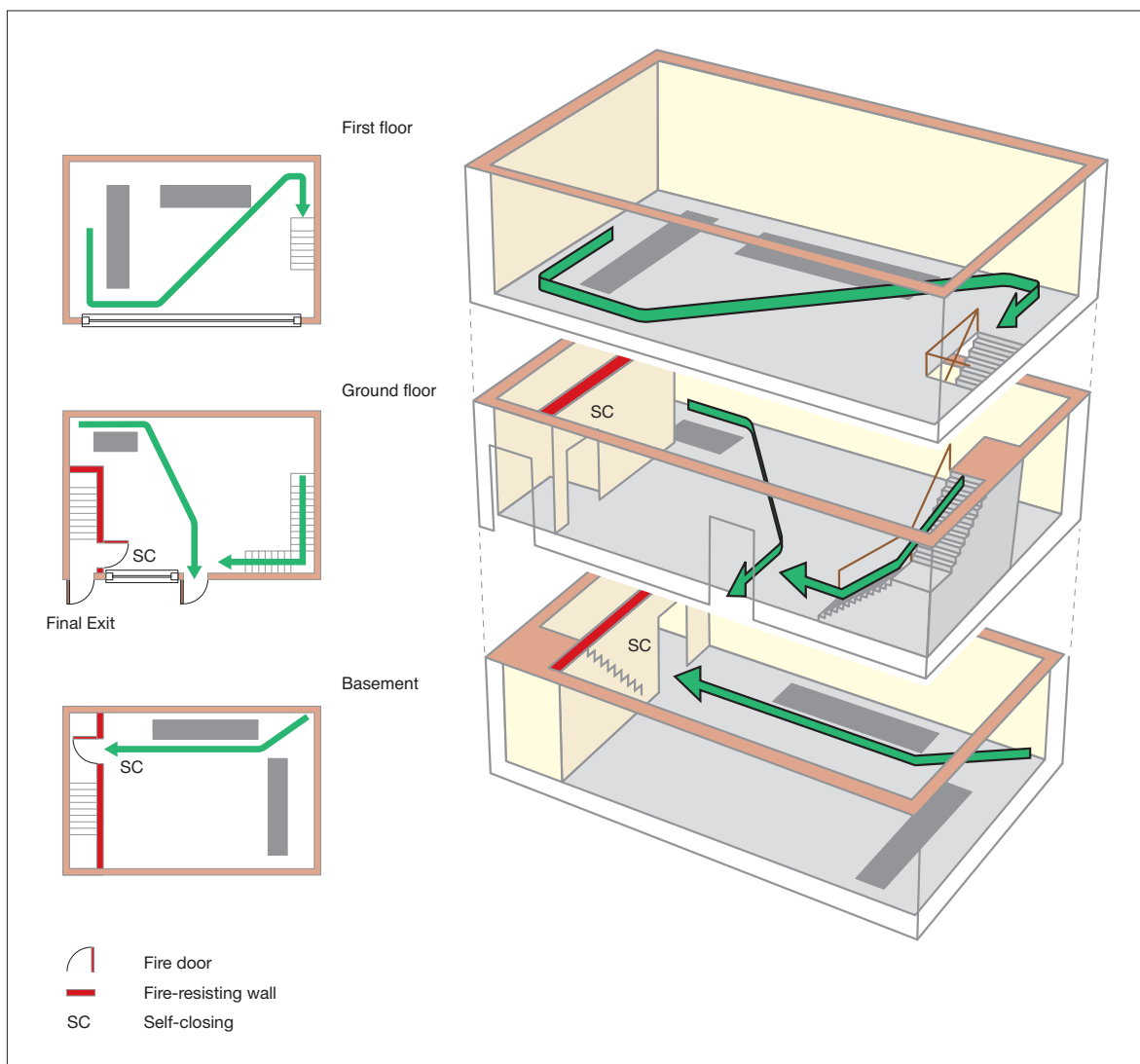
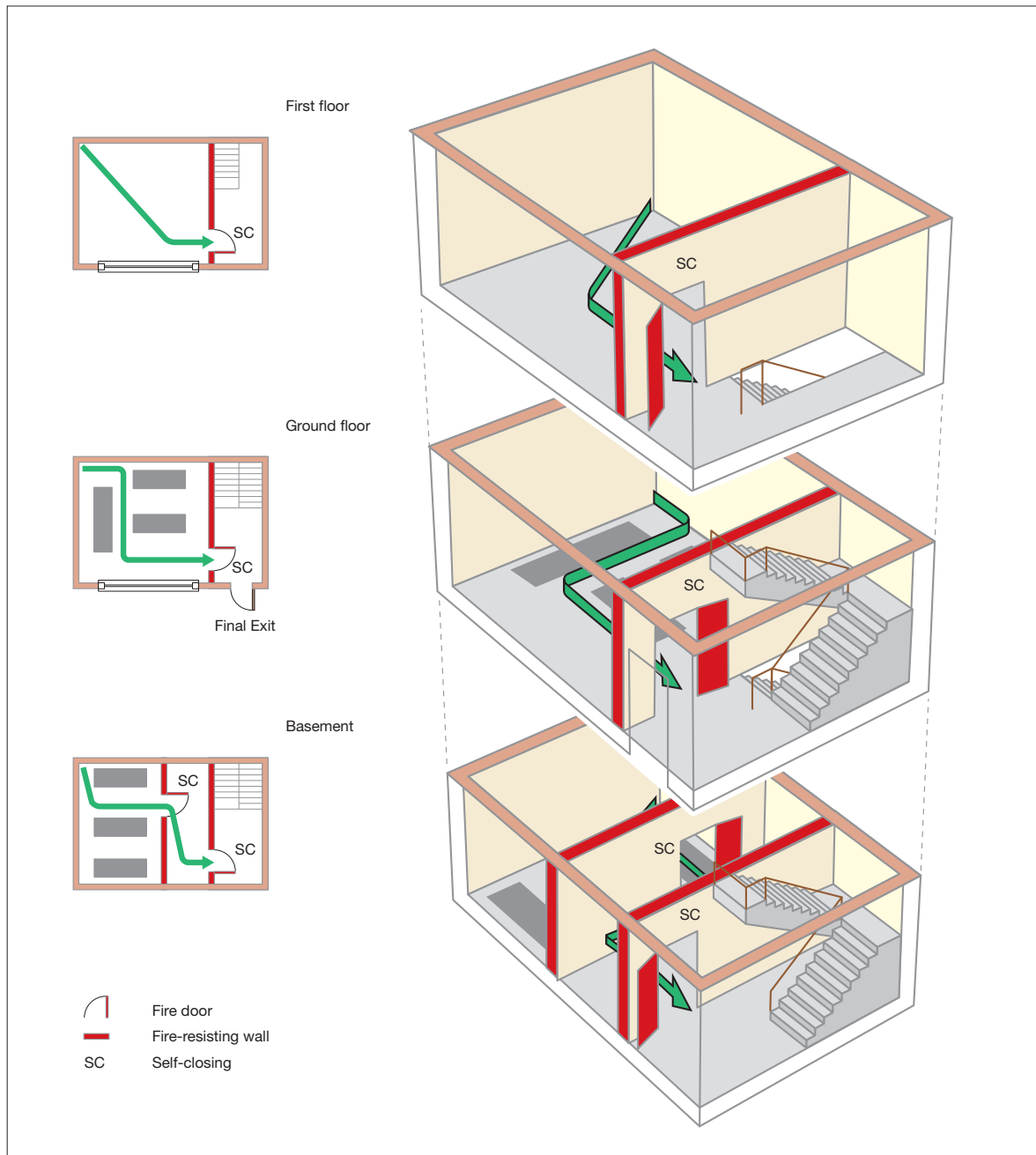

Figure 59: Three-storey premises:
basement, ground and one upper floor



Three-storey premises: basement, ground and one upper floor

In premises with a basement, ground and first floor, served by a single stairway, the layout shown in Figure 59 will be generally acceptable as long as the following apply:

- The basement should accommodate no more than 60 people.
- The first floor should accommodate no more than 60 people.
- To overcome the restriction of travel distance, the stairway has been completely enclosed in 30-minute fire-resisting construction and all doors onto the stairway are self-closing fire doors.
- The furthest point on each floor to the storey exit is within the overall suggested travel distance (see Table 2 on page 78).
- Where the building incorporates a basement, any stairway from the basement is separated by a fire-resisting lobby or corridor between that basement and the protected stairway.

Four storey premises: ground and up to three upper floors

Because of the higher risk posed by premises used as transport facilities with a single stairway to parts of the premises, and to protect the escape route by preventing smoke from entering the stairway, a protected lobby or corridor approach between the stairway and all floors (other than the top floor) should be provided as shown.

If your premises have a ground floor and up to three upper storeys and are served by a single stairway, it is important to understand that you are unlikely to be able to meet the suggested travel distance to a final exit (see Table 2 on page 78). In these circumstances it is necessary to protect the stairway by a fire-resisting enclosure as shown.

The layout shown in Figure 60 will be generally acceptable as long as the following apply:

- The upper floors should each accommodate no more than 60 people.
- The furthest point on each floor to the storey exit is within the overall suggested travel distance (see Table 2 on page 78).
- When a protected lobby or corridor approach to the stairway is employed, the travel distance is measured to the storey exit and not to the door to the lobby or corridor.

Exceptionally for very low risk premises (where occupant densities are low, occupants are familiar with the premises, there is excellent visual awareness and very limited combustibles) automatic fire detection on all floors may be used instead of protected lobbies or corridors (see Figure 61); however, the stairway must still be protected.

If the building you occupy has floors that are occupied by different organisations to your own, you need to consider, as part of your fire risk assessment, the possibility that a fire may occur in another part of the building over which you may have no control and which may affect the protected stairway if allowed to develop unchecked. If your fire risk assessment shows that this may be the case and people using any floor would be unaware of a developing fire, you may require additional fire-protection measures, e.g. an automatic fire-detection and warning system. If this is required, you will need to consult and co-operate with other occupiers and building managers.

Figure 60: Four-storey premises: ground and up to three upper floors – protected by lobbies/corridors

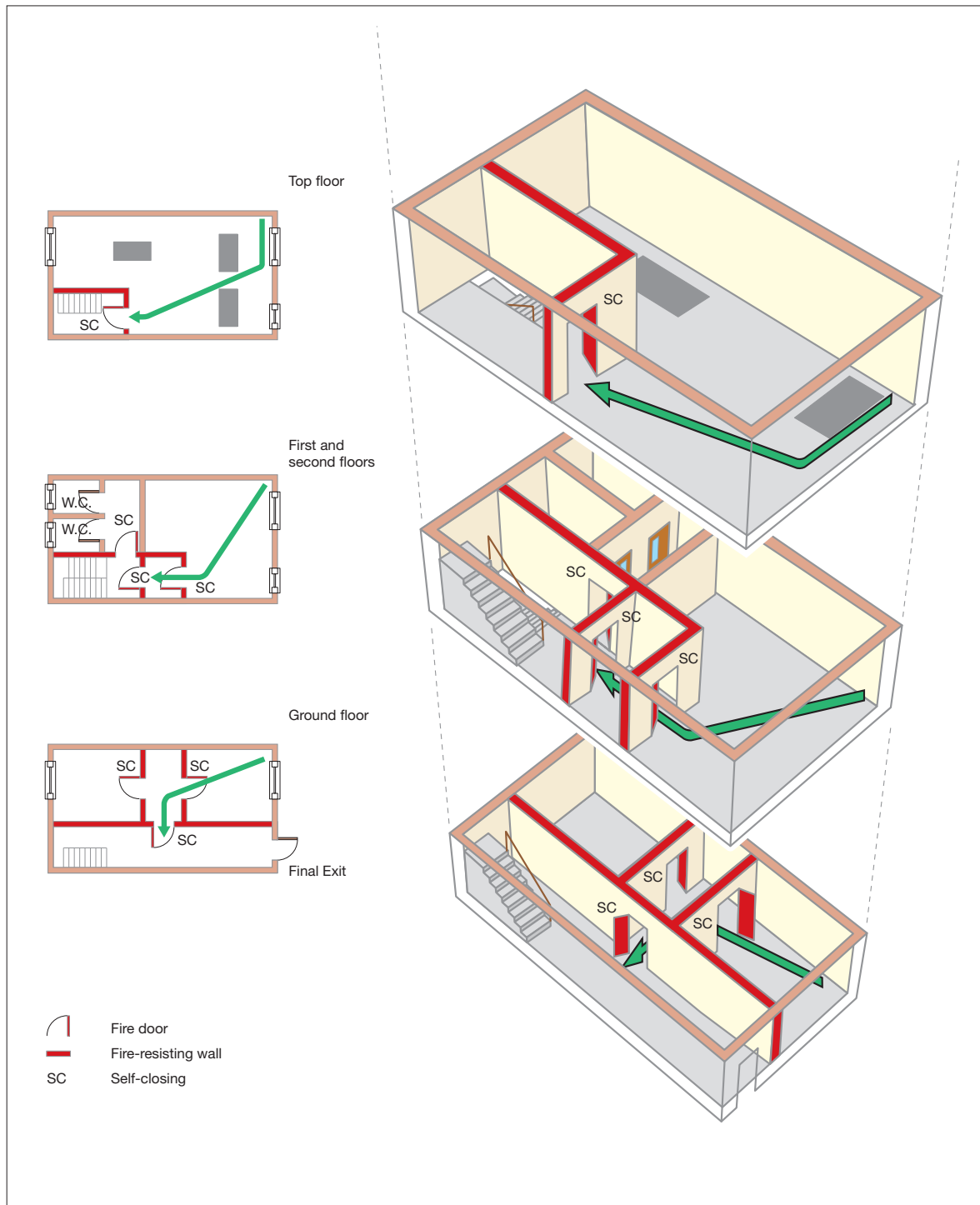
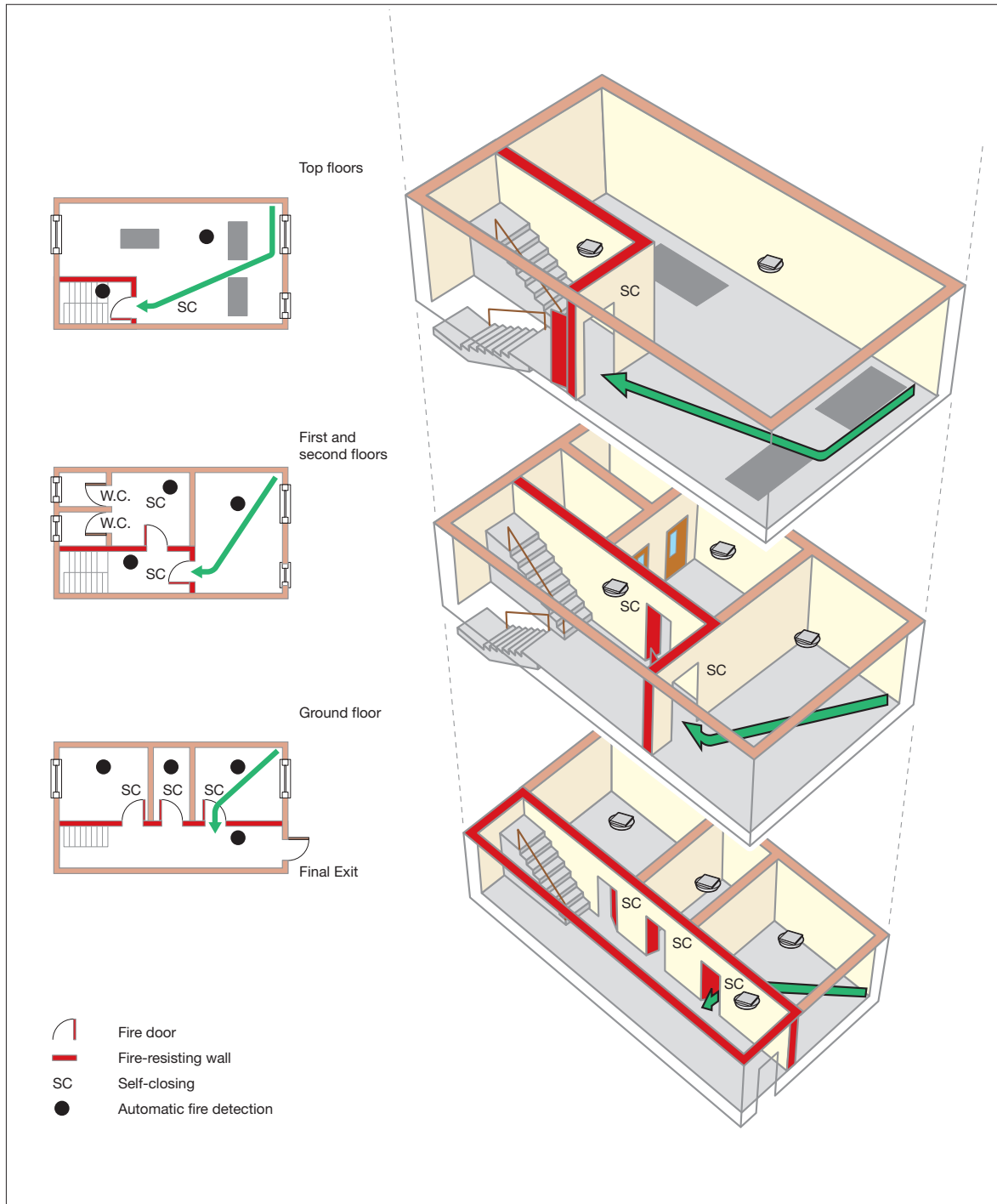

Figure 61: Four-storey premises: ground and up to three upper floors – protected with automatic fire detection



Section 5 Further guidance on emergency escape lighting

The primary purpose of emergency escape lighting is to illuminate escape routes, but it also illuminates safety equipment.

The size and type of your premises and the risk to the occupants will determine the complexity of the emergency escape lighting required.

Single 'stand-alone' escape lighting units may be sufficient in smaller premises, and sometimes these can be combined with exit or directional signs. The level of general illumination should not be significantly reduced by the sign.

In larger, more complex premises, a more comprehensive system of fixed automatic escape lighting is likely to be needed. This will be particularly true in premises with extensive basements or limited natural lighting, or where there are significant numbers of staff and/or members of the public.

You will have identified the escape routes when carrying out your fire risk assessment and need to ensure that they are all adequately lit. If there are escape routes that are not permanently illuminated by normal lighting, such as external stairs, then a switch, clearly marked 'Escape lighting', or some other means of switching on the lighting should be provided at the entry to that area/stairs.

An emergency escape lighting system should normally cover the following:

- each exit door;
- escape routes;
- intersections of corridors;
- outside each final exit and on external escape routes;
- emergency escape signs;
- stairways so that each flight receives adequate light;
- changes in floor level;
- windowless rooms and toilet accommodation exceeding 8m²;
- firefighting equipment;
- fire alarm call points;
- equipment that would need to be shut down in an emergency;
- lifts; and
- halls or other areas greater than 60m².

It is not necessary to provide individual lights (luminaires) for each item above, but there should be a sufficient overall level of light to allow them to be visible and usable.

Emergency escape lighting can be both 'maintained', i.e. on all the time, or 'non-maintained', which only operates when the normal lighting fails. Systems or individual lighting units (luminaires) are designed to operate for durations of between one and three hours. In practice, the three-hour units are the most popular and can help with maintaining limited continued use of your premises during a power failure (other than in an emergency situation).

Figure 62: Luminaires

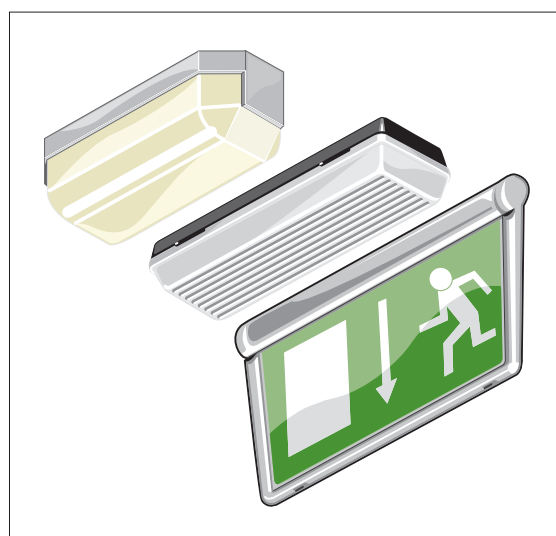

Emergency escape lighting (luminaires) can be stand-alone dedicated units or incorporated into normal light fittings. There are highly decorative versions of these for those areas that demand aesthetically pleasing fixtures. Power supplies can be rechargeable batteries integral to each unit, a central battery bank or an automatic start generator.

To complement emergency escape lighting, people, especially those unfamiliar with the premises, can be helped to identify exit routes by the use of way-guidance equipment. Way-guidance systems usually comprise photoluminescent material, lines of LEDs, or strips of miniature incandescent lamps, forming a continuous marked escape route at lower level (Figure 63). These systems have proved particularly effective when people have had to escape through smoke, including for partially-sighted people. They can be particularly useful in premises where they can provide marked routes on floors and in multi-storey premises they can direct people to escape routes which are seldom used.

Figure 63: A 'way-guidance' system



If you decide that you need to install emergency escape lighting or to modify your existing system, any work should be carried out by a competent person in accordance with the appropriate standards.

If normal or emergency lighting is dimmed during an event, then it should be brought to full illumination when the fire alarm operates.

Further guidance is given in BS 5266-1⁵¹ and BS 5266-8.⁵⁰

Maintenance and testing of emergency escape lighting

All emergency escape lighting systems should be tested regularly and properly maintained to an appropriate standard. Most existing systems will need to be tested manually. However, some modern systems have self-testing facilities that reduce routine checks to a minimum.

Depending on your type of installation you should be able to carry out most of the routine tests yourself. The test method will vary. If you are not sure how to carry out these tests you should contact your supplier or other competent person.

Figure 64: A test key

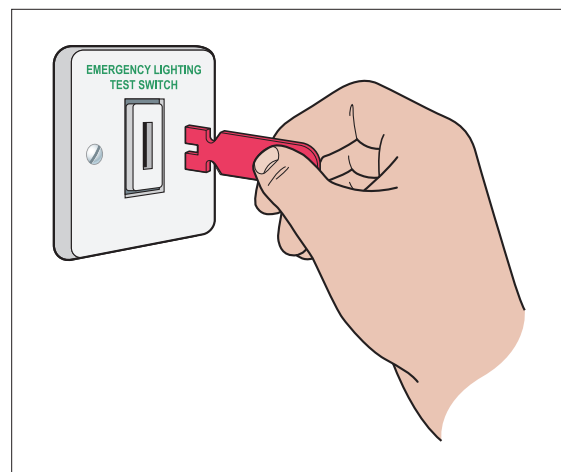

Test facilities often take the form of a 'fishtail' key (see Figure 64) inserted in a special switch either near the main fuse board or adjacent to relevant light switches.

Typically, testing would include:

- a daily visual check of any central controls;
- a monthly function test by operating the test facility for a period sufficient to ensure that each emergency lamp illuminates; and
- an annual full discharge test.

Particular care needs to be taken following a full discharge test. Batteries typically take 24 hours to re-charge and the premises should not be re-occupied until the emergency lighting system is fully functioning unless alternative arrangements have been made. See BS 5266-8⁵⁰ and BS 5266-1⁵¹ for more information.

It is good practice to keep a record of tests.

Section 6 Further guidance on signs and notices

Escape signs

In simple premises, a few signs indicating the alternative exit(s) might be all that is needed. In more complex premises, a series of signs directing people along the escape routes towards the final exit might be needed.

Many people with poor vision retain some sight and are able to recognise changing or contrasting colour to provide them with visual clues when moving around a building. It may be sufficient to paint any columns and walls in a contrasting colour and to highlight changes in level by, for example, making the nosing to step and stair treads a contrasting colour (see BS 8300³³ for further guidance).

For people with no sight, a well managed 'buddy system', continuous handrails, a sound localisation system (which helps people to move towards an alert sound) or the installation of more tactile aids may be appropriate.

People will usually attempt to leave premises by the same way that they entered. As these entrances in public transport premises will then be the exits of choice, it follows that the other emergency exit facilities provided for the premises may not be fully utilised. For this reason, all available exits should be clearly indicated so that the public are aware that there are ways to leave the building other than by the doors which they used to gain admission. In addition, the provision of well sign-posted exits can give a feeling of security in an emergency situation. Note that in most transport premises, the normal entrance and exits are not always signed as fire exits. For example, 'Way out' is sometimes used in exits for normal use.

Exit signs should be clearly visible whenever the public, staff and/or contractors are present.

Positioning of escape signs

The presence of other signs in premises (such as advertising) can distract attention from, or obscure the visibility of, escape signs. This could affect people's ability to see and understand escape signs, particularly if there is an evacuation.

* The Royal National Institute of the Blind estimates that only about 4% of visually impaired people are totally blind.

Always ensure that escape signs are not overwhelmed.

Escape signs should meet the following criteria:

- They should provide clear, unambiguous information to enable people to leave a building safely in an emergency.
- Every escape route sign should, where necessary, incorporate, or be accompanied by, a directional arrow. Arrows should not be used on their own.
- If the escape route to the nearest exit is not obvious then it should be indicated by a sign(s).
- Signs should be positioned so that a person escaping will always have the next escape route sign in sight.
- Escape signs should be fixed above the door in the direction of escape and not be fixed to doors, as they will not be visible if the door is open.
- Signs mounted above doors and hanging signs should be at a height of between 2.0m and 2.5m above the floor.
- Signs on walls should be mounted between 1.7m and 2.0m above the floor.
- Signs should be sited at the same height throughout the escape route, so far as is reasonably practicable.

Escape sign design

For a sign to comply with signs and signals regulations it must be pictographic (see Figure 65 and 66). The pictogram can be supplemented by text if this is considered necessary to make the sign easily understood (BS-type sign), but you must not have a fire safety sign that uses only text.

Figure 65: BS-type sign



Figure 66: Euro sign

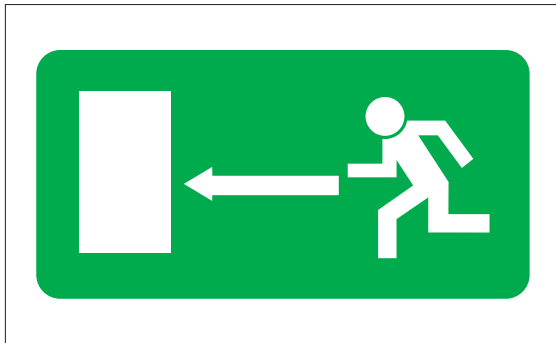

Either type of sign can be used but different types should not be mixed.

The legibility of escape signs is determined by the size of the sign, its level of illumination and the distance over which it is viewed. The use of signs within the same premises should follow a consistent design pattern or scheme. You should not rely on a few oversized signs which may encourage people to travel to a particular escape route when other more appropriate routes should be used.

In multi-occupied premises, co-operation between the respective responsible persons should be sought to ensure that, as far as possible, all signs in the building conform to a single pattern or scheme.

Other safety signs and notices

A number of other mandatory signs such as 'Fire action' notices may also be necessary.

Fire doors that have been fitted with self-closing devices should be labelled 'Fire door – keep shut' on both sides (see Figure 67). Fire-resisting doors to cupboards, stores and service ducts that are not self-closing because they are routinely kept locked should be labelled 'Fire door – keep locked' on the outside.

Figure 67: 'Fire door – keep shut' notice



Figure 68: Fire action notice



Staff notices

In simple premises where there are a limited number of escape routes, it may be reasonable to provide staff with verbal reminders of what they need to do if there is a fire. In some premises, you could consider providing a short written statement that could, for example, be delivered with staff pay slips every six months.

In multi-occupied, larger and more complex premises or where there is a high turnover of staff, a more considered approach for staff notices and instructions will be necessary. As well as positioning the fire instructions notice on escape routes adjacent to fire break-glass call points (see Figure 68), put them where staff frequently assemble in the premises, e.g. the canteen and locker rooms.

In some premises, consider whether it is suitable for fire instruction notices to be available in public areas or whether they should only be in areas to which staff have access.

Illumination

All signs and notices will need illumination to ensure they are conspicuous and legible. There are a number of options available to achieve this, such as:

- external illumination; and
- internal illumination.

The supplier or other competent person can give you further advice.

All exit and directional signs indicating the exits from any part of the premises to which the public are admitted should (unless they are self-luminous fire safety signs) be illuminated by means of the normal lighting and the emergency escape lighting at all times when the public are on the premises.

Signs or notices of the photo-luminescent type, i.e. where the active material making up the luminous parts of such signs or notices needs a period of exposure to light before they become visible in darkness (but get fainter with time), are not a substitute for appropriate emergency lighting and should only be used where other forms of illumination are present.

Further guidance

Further guidance on fire safety signs can be found in BS 5499-4⁵² and BS 5499-5.⁵³ Published guidance¹³ on compliance with health and safety legislation on signs is also available. Guidance about the use of photo-luminescent fire safety signs and notices can be found in BS 5266-6⁷⁷.

Section 7 Further guidance on recording, planning, informing, instructing and training

7.1 Fire safety records

Keeping up-to-date records of your fire risk assessment can help you manage the fire strategy for your premises effectively and demonstrate how you are complying with fire safety law. It is recommended that fire safety records should be kept to demonstrate that the responsible person is complying with the requirements of the Order. Records should be kept for long enough for management to demonstrate that the programmed maintenance and staff training is carried out over a period of time.

Even if you do not have to record the fire risk assessment, it can be helpful to keep a record of any co-operation and exchange of information made between employers and other responsible people for future reference.

In larger and more complex premises, it is best to keep a dedicated record of all maintenance of fire-protection equipment and training. There is no one 'correct' format specified for this. Suitable record books are available from trade associations and may also be available from your local enforcing authority.

In all cases, the quality of these records may also be regarded as a good indicator of the overall quality of the safety management structure.

Your records should be kept in a specified place on the premises (e.g. in the management's office), and should include:

- details of any significant findings from the fire risk assessment and any action taken (see Part 1, Section 4.1);
- testing and checking of escape routes, including final exit locking mechanisms, such as panic devices, emergency exit devices and any electromagnetic devices;
- testing of fire-warning systems, including weekly alarm tests and periodic maintenance by a competent person;
- recording of false alarms;
- testing and maintenance of emergency lighting systems;
- testing and maintenance of fire extinguishers, hose reels, fire blankets, etc.;

- if appropriate, testing and maintenance of other fire safety equipment;
- training of relevant people and recording of fire evacuation drills;
- policy, planning, organising, implementation, monitoring, audit and review;
- maintenance and audit of any systems that are provided to help the fire and rescue service;
- the arrangements in a large multi-occupancy building for a co-ordinated emergency plan or overall control of the actions you or your staff should take if there is a fire; and
- all alterations, tests, repairs and maintenance of the fire safety systems, including passive systems such as fire doors.

Other issues that you may wish to record include:

- the competence, qualifications and status of the persons responsible for carrying out inspections and tests;
- the results of periodic safety audits, reviews, inspections and tests, and any remedial action taken;
- all incidents and circumstances which had the potential to cause accidents and monitor subsequent remedial action; and
- a record of the building use, the fire prevention and protection measures in place and high-risk areas.

You should ensure that no other management decisions or policies compromise safety.

Your documentation should be available for inspection by representatives of the enforcing authority.

In premises with engineered fire safety strategies, a fire policy manual should be provided in addition to any other records. Enforcing authorities would expect a fire engineering policy manual to conform to the structure set out in BS 7974, Section 5.⁵⁴

More detailed advice is given in BS 5588-12.¹⁵

Figures 69 and 70 are examples of how to record some individual stages of the process in more detail. A blank version of this form is provided in Appendix A2.

Figure 69: Example record of risk assessment summary: internal fire

Risk Assessment – Record of significant findings		
Risk assessment for		Risk assessment by
Company		Date
Facility	Airport	Completed by
Address		Signature
Sheet number	Location	Use
	Gate room	Transit
Step 1 – Identify fire hazards		
A fire at the gate room		
Sources of ignition	Sources of fuel	Sources of oxygen
Electrical equipment at the gate desk, e.g. PCs printers Vending machines Flat screen television Illuminated advertising panel	Air Forced ventilation	Boxed paper Electrical equipment Fixtures and fittings Magazines and newspapers Rubbish bin contents
Step 2 – People at risk		
People at risk	Special risks	
Airport staff Airline staff and other employees at the airport Passengers Visitors	Mobility impaired Hearing impaired Visually impaired Unaccompanied minors Tourists (no English) Sleeping risk Mothers with children	
Number of people in gate room		
Passengers	350	
Staff and accompanied visitors	Airport	
Step 3 – Evaluate, remove, reduce and protect from risk		
Existing fire precautions	1) 3 fire exits @ 1800mm clear width 2) Fire extinguishers at gate desk 3) Escape signage 4) Fire alarm system incorporating manual call points	
Evaluation of the likelihood of a fire occurring	Medium/High: no maintenance of electrical equipment	
Evaluation of the risk to people from a fire occurring	Loss of a fire exit due to the location of the fire (1 of 3 exits lost), resulting in an increased time for evacuation and an increased exposure to smoke/toxic combustion products. Potential for fire spread via neighbouring soft furnishings.	
Removal or reduction of the fire hazards	1) Introduce regular maintenance of electrical equipment, e.g. PAT 2) Provide metal rubbish bins with flip tops or lids and empty these regularly to reduce potential fire load 3) Construct the gate desks from ignition-resistant materials 4) Ensure surrounding furniture meets the requirements of the Furniture and Furnishings (Fire Safety) Regulations 1988	

Removal or reduction of the risks to people	<ul style="list-style-type: none"> 1) Train gate staff in the use of fire extinguishers 2) Install automatic fire detection to provide early warning of fire. Visual beacons for hearing impaired 3) Train staff to assist in the evacuation of occupants with special needs 4) Improve housekeeping to ensure clear routes for egress through the gate room to alternative exits 5) Manage the number of occupants in the gate room to avoid overcrowding, e.g. delays during evacuation 	
Step 4 – Record, plan, inform, instruct and train		
Significant finding	People are at risk from a fire at the gate room desk	
Actions required	Delivery dates	Action owner/date completed
Install and complete measures 1 to 4 to reduce the fire hazards	Less than 1 month	
Install and complete measures 1 to 5 to reduce the risk to people	Less than 3 months	
Review risk assessment, taking account of delivery time for other significant findings to identify whether any temporary measures are required pending completion of the work identified	Immediate	
Update evacuation plan	Less than 3 months	
Existing fire precautions	<ul style="list-style-type: none"> 1) Update the emergency plan to incorporate the actions to be taken upon activation of the automatic fire-detection and alarm system 2) Update the emergency plan to incorporate the agreed new roles and responsibilities of staff 	
Inform, instruct, co-operate and co-ordinate	<ul style="list-style-type: none"> 1) Consult with relevant staff and their representatives regarding the proposed new roles and responsibilities in an evacuation of the gate room 2) Confirm their agreed roles and responsibilities 3) Inform relevant staff of the new life-safety system to be installed 4) Advise the local fire service of significant modifications to the building 	
Fire safety training	<ul style="list-style-type: none"> 1) Undertake the fire safety training required to allow staff to effectively perform their new roles and responsibilities in the evacuation 2) Undertake fire extinguisher training for relevant staff 	
Step 5 – Review		
Assessment review date	Completed by	Signature

Figure 70: Example record of risk assessment summary: external fire

Risk Assessment – Record of significant findings		
Risk assessment for		Risk assessment by
Company		Date
Facility	Airport	Completed by
Address		Signature
Sheet number	Location	Use
	Gate room	Transit
Step 1 – Identify fire hazards		
A fire outside the building that could spread to the gate room via openings in the façade, via windows or the non-fire-rated construction of the façade		
Sources of ignition	Sources of fuel	Sources of oxygen
Fuelling rig Aero-engines Standby generator Airside vehicles Air bridge systems (electro-mechanical) Construction works within locality of aircraft stand (hot works)	Air Chemicals in cargo Gases in cargo Liquids in cargo	Fuel hydrants Vehicles, e.g. catering, baggage Electrical equipment (standby generator) Construction materials Chemicals, gases, liquids in cargo
Step 2 – People at risk		
People at risk	Special risks	
Airport staff Airline staff and other employees at the airport Passengers Visitors	Mobility impaired Hearing impaired Visually impaired Unaccompanied minors Tourists (no English) Sleeping risk Mothers with children	
Number of people in gate room		
Passengers	350	
Staff and accompanied visitors	Airport	
Step 3 – Evaluate, remove, reduce and protect from risk		
Existing fire precautions	1) External fire hazards (refuelling, storage, fuel hydrants) – guidance in CAA publication CAP 748 followed 2) Airside safety management follows guidance in CAA publication CAP 642 3) Consultation with aerodrome fire and rescue service and emergency plans in place with them for assistance during airside evacuation (CAP 168 Licensing of Aerodromes)	
Evaluation of the likelihood of a fire occurring	Low: management of refuelling practices, all equipment regularly serviced and construction activities based on permit to work scheme	
Evaluation of the risk to people from a fire occurring	Loss of the fire exit which leads to the apron (1 of 3 exits), resulting in an increased time for evacuation. Impact of radiation exposure on occupants limited by the remaining exits being located at the rear of the gate room (escape away from the fire)	

Removal or reduction of the fire hazards	1) No construction works allowed while aircraft stand is operational, controlled via permits to work	
Removal or reduction of the risks to people	1) Utilise horizontal evacuation to avoid occupants being exposed to risks associated with the apron 2) Manage the number of occupants in the gate room to avoid overcrowding, e.g. delays to evacuation 3) Train staff to assist in the evacuation of occupants with special needs 4) Improve housekeeping to ensure clear routes for egress through the gate room to alternative exits	
Step 4 – Record, plan, inform, instruct and train		
Significant finding	People are at risk from a fire outside (apron level)	
Actions required	Delivery dates	Action owner/date completed
Install and complete measure 1 to reduce the fire hazard	Immediate	
Install and complete measures 1 to 4 to reduce the risk to people	Less than 1 month	
Emergency plans	1) Update the emergency plan to incorporate the agreed new roles and responsibilities of staff	
Inform, instruct, co-operate and co-ordinate	1) Consult with relevant staff and their representatives regarding the proposed new roles and responsibilities in an evacuation of the gate room 2) Confirm their agreed roles and responsibilities 3) Inform the estates department and operations that aircraft stands cannot be used while construction activity is under way. A permit to work scheme is required for all airside construction activities	
Fire safety training	1) Undertake the fire safety training required to allow staff to effectively perform their new roles and responsibilities in the evacuation	
Step 5 – Review		
Assessment review date	Completed by	Signature

Fire safety audit

A fire safety audit can be used alongside your fire risk assessment to identify what fire safety provisions exist in your premises.

When carrying out a review of your fire safety risk assessment, a pre-planned audit can quickly identify if there have been any significant changes which may affect the fire safety systems and highlight whether a full fire risk assessment is necessary.

Plans and specifications

Plans and specifications can be used to assist understanding of a fire risk assessment or emergency plan. Even where not needed for this purpose, they can help you and your staff keep your fire risk assessment and emergency plan under review and help the fire and rescue service in the event of fire. Any symbols used should be shown on a key. Plans and specifications could include the following:

- essential structural features such as the building layout, escape doors, wall partitions, corridors, stairways, etc (including any fire-resisting structure and self-closing fire doors provided to protect the escape routes);
- location of refuges and lifts that have been designated suitable for use by disabled people and others who may need assistance to escape in case of a fire;
- methods for fighting fire (details of the number, type and location of the firefighting equipment);
- location of manually-operated fire alarm call points and control equipment for fire alarms;
- location of control rooms and stewards posts;
- location of any emergency lighting equipment and the exit route signs;
- location of any high-risk areas, equipment or process that must be immediately shut down by staff on hearing the fire alarm;
- location of any automatic firefighting systems, risers and sprinkler control valves;
- location of dry/wet fire mains inlet and outlet valves;
- location of the fire plans box and/or fire control panels;
- location of the main electrical supply switch, the main water shut-off valve and, where appropriate, the main gas or oil shut-off valves; and

- plans and specifications relating to all recent constructions.

This information should be passed on to any later users or owners of the premises.

7.2 Emergency plans

Emergency plans and contingency plans

The purpose of an emergency plan is to ensure that the people in your premises know what to do if there is a fire and that the premises can be evacuated safely.

You should identify all the roles and responsibilities of staff required to implement the emergency procedures for every scenario identified in your emergency plan. The number of staff required will depend on the emergency scenario, roles and responsibilities identified, passenger to staff ratio needs, size and complexities of the premises, operational hours (i.e. shift work requiring contingency considerations), and contingencies for sick and annual leave. Particular regard should be given to sub-surface stations or platforms, where the level of staffing will need to be higher but must at all times be sufficient for the safe evacuation of all passengers who may be at the station or arriving at the station from trains. These considerations are only provided as a guide and other factors may also apply.

Your emergency plan should be appropriate to your premises and could include:

- what staff should do if they discover a fire;
- how people will be warned if there is a fire;
- the numbers, duties and identity of staff who have specific responsibilities if there is a fire;
- how staff will communicate with each other during an emergency, particularly between sub-surface areas and the surface, in order to facilitate a safe evacuation of the premises;
- identification of key escape routes, how people can gain access to them and escape from them to a place of total safety;
- how the evacuation of the premises should be carried out (including the use of means of transport as a method of evacuation, e.g. trains);

- arrangements for the safe evacuation of people identified as being especially at risk, such as children, those with disabilities or lone workers;
- where staff and visitors should assemble after they have left the premises and procedures for checking whether the premises have been evacuated;
- specific arrangements, if necessary, for high fire-risk areas;
- any machines, processes, appliances or power supplies that need to be stopped or isolated if there is a fire;
- contingency plans for when life-safety systems, such as evacuation lifts, fire-detection and warning systems, sprinklers or smoke control systems, are out of order;
- means of stopping people from entering the premises in the event of an emergency;
- arrangements for fighting the fire;
- how the fire and rescue service and any other necessary services will be called and who will be responsible for doing this;
- procedures for meeting the fire and rescue service on their arrival, advising them of the nature and location of the incident and notifying them of any special risks, e.g. the location of highly flammable materials;
- what training employees need and the arrangements for ensuring that this training is given; and
- phased evacuation plans (where some areas are evacuated while others are alerted but not evacuated until later).

Figure 71: Managed crowd control



As part of your emergency plan it is good practice to prepare post-incident plans for dealing with situations that might arise such as those involving:

- unaccompanied children;
- people with personal belongings (especially valuables) still in the building;
- getting people away from the building (e.g. to other means of transport); and
- inclement weather.

You should also assess the risk of any incident occurring which might prejudice public safety or disrupt normal operations, for example power cuts, bomb threats or crowd disorder. Since a fire may be associated with some other emergency, your various response procedures should be integrated.

Consultation should, therefore, take place between yourself, your staff and their representatives and the relevant authorities (e.g. police, fire and ambulance services, the local health authority and local authority) in order to produce an agreed plan of action, including access for emergency vehicles, for all foreseeable incidents.

Guidance on developing health and safety management policy has been published by the HSE.⁵⁵

Transport management planning

Your fire emergency plan should consider the actions required of transport vehicles (and the controlling infrastructure, e.g. signals) within, or about to enter, the facility during a fire emergency.

The consideration required is best illustrated by an example of a fire in an sub-surface station.

Train at the platform of a sub-surface station

Allowing the train to leave might allow more station occupants to evacuate the station quickly. This would lessen the occupancy load on the station infrastructure providing the means of escape.

The movement of the train as it leaves the station might induce undesirable air flows within the station and associated pedestrian tunnels, placing additional people at risk from combustion products from the fire (smoke, hot gases or toxic gases). Conversely, the additional free volume in the station might aid combustion product dilution.

Train about to enter a sub-surface station

If the train does not enter the station, the train passengers might be at risk as smoke spreads through the tunnels.

If the train stops at the station platform:

- it might allow some station occupants to evacuate quickly;
- conversely, some passengers may alight on to the platform;
- people on the train might be placed at risk, particularly if there is some difficulty in arranging for an overcrowded train to leave the station; and
- the movement of the train might induce undesirable air flows within the station and associated tunnels.

If the train passes through the station without stopping, then:

- the train passengers are not placed at risk; but
- the movement of the train might induce undesirable air flows within the station and associated tunnels.

In any case in which the train moves, there is a possibility that station occupants may have chosen to move down the tunnels, placing themselves at risk from a moving train.

Sub-surface railway station management planning

Considerations of particular relevance to sub-surface railway stations are identified in the following points.

- Good practice is for the public and non-public areas to be separated by fire-resisting construction. If this is not possible, then the nearest practicable wall to the public area is fire-resisting and sprinklers are installed within the area that is not separated from the public area.
- Fire-resisting construction is usually provided to isolate machine rooms, substations, transformer rooms, electrical or signal rooms, rooms containing cooking facilities and staff rooms.
- Automatic fire detection is usually provided within machine rooms, at escalators, in office areas (particularly those that are not of fire-resisting construction) and in any staff rooms.

- Public address or voice alarm systems are available.
- The use of combustibile materials in sub-surface stations is minimised. Posters are attached to non-combustible surfaces only, using water-based adhesive and with a maximum of four layers of paper.
- Sprinkler protection is typically provided in machine rooms, store rooms and shops and above escalators.
- Sufficient numbers of trained staff are available to facilitate a managed evacuation in a fire emergency. Training is supported by the use of fire drills. Contractors are supervised while on the premises.
- Consideration is given to:
 - the availability (and potential complexity) of the escape routes, together with the number of people who may need to use them;
 - the movement of air and the products of combustion within sub-surface stations (and how they are affected by train movements) plus their likely impact upon a managed evacuation;
 - the management of trains;
 - the management of escalators and/or lifts;
 - maintenance of station records;
 - the availability of a plans box outside the station, usually at the designated fire and rescue service access point; and
 - the availability of access to the fire for the fire and rescue service.

Rail tunnel management planning

As part of your emergency plan (which may form part of your operating procedures), you may need to consider:

- training of railway staff;
- emergency information for passengers;
- whether passengers are expected to walk on a walkway when they leave the train (the walkway can be at the train door level);
- whether passengers need to alight from the train and walk along the ground (note that this may be at track level);
- whether passengers can escape via a cross-passage(s) connected to an adjacent tunnel; and
- whether passengers have to travel along the tunnel to a final exit at a portal or station.

You should pay particular attention to how and when passengers should be informed of a fire.

When making appropriate necessary contacts with the emergency services, you may need to discuss with them matters such as:

- arranging disconnection and earthing of the traction current;
- whether any water supply for the fire and rescue service is available on site;
- whether radio communications work in tunnels; and
- exercises involving emergency services (to practise communication and co-ordination between railway and rescue service staff).

Road tunnel management planning

Fire emergency considerations relevant to road tunnels may include the following:

- escape routes and emergency exits;
- access for the emergency services;
- drainage provisions for flammable and toxic liquids;
- emergency lighting;
- emergency ventilation;
- the firefighting water supply;
- communication systems; and
- emergency stations.

In the event of a fire emergency within a road tunnel, your plan should consider the following points:

- whether the tunnel should be closed to traffic, e.g. by the simultaneous activation of barriers before the tunnel entrances. Other means of closing the tunnel without barriers should be considered;
- whether traffic within the tunnel should be stopped as soon as possible, e.g. by the use of variable message signs, traffic signals and/or mechanical barriers inside the tunnel (if available);
- whether traffic should be managed in such a way that unaffected vehicles can leave the tunnel quickly;
- whether the access time for the emergency services to reach a fire incident in the tunnel should be considered as part of your emergency plan. This response time could be measured during periodic exercises or it may be measured during incidents; and

- in tunnels requiring a control centre, that a single control centre has full control during a fire emergency within the tunnel.

The monitoring systems that can be deployed to facilitate closure of the tunnel in a fire emergency may include:

- video monitoring systems linked to a control centre;
- automatic stopped vehicle detection systems linked to a control centre;
- automatic fire-detection systems linked to a control centre; and
- automatic fire-detection systems linked directly to the tunnel closure system.

For the transport of dangerous goods through road tunnels, you may need to consider the following additional planning and operational requirements:

- identification of the risks associated with the transportation of dangerous goods through the tunnel;
- specific operating measures designed to reduce the risks relating to some or all of the vehicles transporting dangerous goods through the tunnel (on a case-by-case basis depending on the risks identified), e.g. declaration before entering the tunnel or passage in convoys escorted by accompanying vehicles; and
- appropriate signs placed before the last possible exit before the tunnel and at the tunnel entrances so as to allow drivers of vehicles transporting dangerous goods to choose an alternative route.

Airport management planning

The following points highlight considerations that are particular to some airport terminals:

- external fire hazards – from fuel stores, fuel hydrants, fuel tankers and during aircraft refuelling operations. Further guidance is provided in CAA publication CAP 748;⁵⁶
- aircraft loading stands located close to external fire hazards – during passenger loading, a substantial number of people may be located within the loading stand, leading to difficulties in satisfying the requirements for the means of escape;
- evacuation routes from terminal buildings, which may require passengers and other members of the public to enter airside areas, even directly onto operational aircraft aprons or stands where there may

be significant hazards. Further guidance on airside safety management is provided in CAA publication CAP 642: *Airside safety management*;⁵⁷

- attendance of the aerodrome rescue and firefighting service to assist with incidents where evacuation airside may take place – this should be included in the aerodrome emergency plan. Further guidance is provided in CAP 168: *Licensing of aerodromes*;⁵⁸
- progressive horizontal evacuation – this evacuation strategy requires suitable structural provision, careful evacuation management planning, appropriate training for staff and sufficient staff to implement the evacuation plan in a fire emergency. Horizontal evacuation is particularly appropriate in an airport terminal building for the following reasons:
 - to prevent people having to enter a hostile environment such as the airport apron;
 - to avoid disruption to the operation of the building;
 - to avoid the airside/landside barriers being breached;
 - to avoid the segregation of arriving/departing passengers being breached; and
 - to assist in the evacuation of people with disabilities;
- language difficulties – it is likely that an airport terminal will contain occupants who do not speak English (or for whom English is not their first language);
- lift, escalator and travelator management planning;
- escalator, travelator and baggage belt maintenance – by their very nature, heat will be generated by the friction within bearings and between moving parts. Regular maintenance along with robust management of dust and rubbish removal is essential;
- staff fire emergency training – e.g. fire precautions training, ‘hands-on’ first aid, firefighting training, evacuation marshal training, alarm responder training, fire risk assessment training, catering fire precautions training and hot works supervisor training;
- special hazards – chemicals, gases, liquids or radioactive sources found in cargo;

- transport interchange facilities – where there is a transport interchange facility interconnecting with a terminal building, compartmentation should normally be provided between the two unless it can be shown by specific risk assessment that the risk of fire or smoke spread between the two is reduced to an acceptable level; and
- aircraft management planning, e.g. if the fire is in the air control tower.

Lift management planning

You need to consider the operation of lifts in a fire emergency. Typically, all lifts will be interfaced with the fire alarm system. On activation of the fire alarm:

- all lifts return to the ground floor;
- at this level, the lift doors open and passengers are discharged;
- the doors of a firefighting lift(s) remain open, while the doors of all other lifts close; and
- all calls (other than those within the lift car) are made inoperative.

The firefighting lift(s) (under the control of the fire and rescue service) and/or evacuation lift(s) (under the control of the appropriate appointed representative of the management) are then made ready for operation according to the emergency plan.

The cause and effect lift strategy must be compatible with the fire strategy for the building.

Escalator and travelator management planning

Where escalators are used to provide the means of escape from your premises, the escalators should be operated under management control (i.e. the escalators do not stop on activation of the fire alarm, but will be stopped – or reversed – under manual control if deemed necessary).

7.3 Information, instruction, co-operation and co-ordination

Supplying information

You must provide easily understandable information to employees, the parents of children you may employ, and to employers of other persons working in your premises about the measures in place to ensure a safe escape from the building and how they will operate, for example:

- any significant risks to staff and other relevant persons that have been identified in your fire risk assessment or any similar assessment carried out by another user or responsible person in the building;
- the fire prevention and protection measures and procedures in your premises and how they impact on staff and other relevant persons in the building;
- the procedures for fighting a fire in the premises; and
- the identity of people who have been nominated with specific responsibilities in the building.

You need to ensure that all staff and, where necessary, other relevant persons in the building, receive appropriate information in a way that can be easily understood. This might include any special instructions to particular people who have been allocated a specific task, such as shutting down equipment or guiding people to the nearest exit.

Information for the fire and rescue service

Increasingly, fire engineering is being incorporated in transport facilities, including in many with complex layouts and/or interconnecting spaces (e.g. airport terminals, sub-surface railway stations, transportation interchanges), to enable developers to meet functional building requirements specifically with regard to integrating a number of fire safety systems (e.g. automatic fire detection and alarm, sprinklers, smoke ventilation, automatic fire shutters, emergency lighting and evacuation management) to achieve an acceptable level of fire safety. Attending crews may have to interact with these systems and therefore need accurate, concise and up-to-date information when developing firefighting tactics.

You should consider providing a plans box in consultation with the local fire safety officer (FSO), to provide up-to-date information at the point of use. You, as the responsible person, e.g. owner or occupier, are best placed to maintain such information, and carrying out this exercise will assist in your fire risk assessment process. The system is intended to be simple, developed as part of the building design and risk assessment process, and easily maintained. It is essentially a box containing plans and information about the building in a standard format.

The London Fire Emergency Planning Authority (LFEPA) produces a procedural note that gives advice on maintaining premises information boxes (plans boxes)⁵⁹ and is intended for buildings that have one or more of the following:

- a fire-engineered solution;
- a complex layout;
- complex firefighting facilities and/or controlling equipment; and
- the provision of such information is agreed as necessary.

The information in the plans box is not intended to replace the normal information gathering and familiarisation carried out by fire crews but may assist in this process.

The contents of the plans box should be tailored to suit your premises. The plans should be kept simple and useable but contain key information needed by operational crews when there is an incident. Typical information held within a plans box might include:

- operational contingency plans;
- simple plans and/or schematic representations of the building;
- any relevant information relating to the design and operation of equipment or fixed installations provided for means of escape or firefighting operations;
- basic operating instructions for fire protection and fixed firefighting equipment;
- information on any fire-engineered solutions; and
- any other relevant information.

Further guidance is given in the LFEPA/LFB premises information box safety note.⁵⁹

In addition to providing the above information, it will also be helpful to inform the fire and rescue service of any short-term changes that might have an impact on their firefighting activities (e.g. the temporary loss of a firefighting facility and/or temporary alterations).

Duties of employees to give information

Employees also have a duty to take reasonable care for their own safety and that of other people who may be affected by their activities. This includes the need for them to inform their employer of any activity that they consider would present a serious and immediate danger to their own safety and that of others.

Dangerous substances

HSE publishes guidance¹⁷ about specific substances where appropriate information may need to be provided. If any of these, or any other substance that is not included but nevertheless presents more than a slight risk, is present in your premises, then you must provide such information to staff and others. Specifically you must:

- name the substance and the risks associated with it, e.g. how to safely use or store the product to avoid creating highly flammable vapours or explosive atmospheres;
- identify any legislative provisions that may be associated with the substance;
- allow employees access to the hazardous substances safety data sheet; and
- inform the local fire and rescue service where dangerous substances are present on the premises.

Instruction

You will need to carefully consider the type of instructions to be given to staff and other people working in your premises. Written instructions must be concise, comprehensible and relevant and therefore must be reviewed and updated as new working practices and hazardous substances are introduced.

Inclusive access and employment policies mean that people with learning difficulties may now be present in a range of premises and your fire risk assessment should consider whether further instruction or guidance is necessary to ensure that your evacuation strategy is appropriate and understood by everyone.

Instructions will need to be given to people delegated to carry out particular tasks, for example:

- removing additional security, bolts, bars or chains on final exit doors before the start of business to ensure that escape routes are accessible;
- daily, weekly, quarterly and yearly checks on the range of fire safety measures (in some premises some of the work may be contracted out to a specialist company);
- safety considerations when closing down the premises at the end of the day, e.g. removing rubbish, ensuring enough exits are available for people who remain and closing fire doors and shutters;

- leaving hazardous substances in a safe condition when evacuating the building;
- the safe storage of hazardous substances at the end of the working day; and
- ensuring everyone in large organisations with many buildings within a curtilage or fence defining the boundary and/or security zone know how to use internal emergency telephones.

Specific instructions may be needed about:

- how staff will help members of the public/visitors to leave the building;
- how staff will guide people to the nearest exit when the fire alarm sounds;
- designating particular areas of your premises to nominated staff to check that no one remains inside;
- calling the emergency services;
- carrying out evacuation roll calls (for members of staff);
- taking charge at the assembly area;
- meeting and directing fire and rescue service vehicles; and
- cover arrangements when nominated people are on leave.

Co-operation and co-ordination

Where you share premises with others, each responsible person, i.e. each employer, owner or other person who has control over any part of the premises, will need to co-operate and co-ordinate the findings of their separate fire risk assessments to ensure the fire precautions and protection measures are effective throughout the building. This could include:

- co-ordinating an emergency plan (see Section 7.2 for features of an emergency plan);
- identifying the nature of any risks and how they might affect others in or about the premises;
- identifying any fire-prevention and protection measures;
- identifying any measures to mitigate the effects of a fire; and
- arranging any contacts with external emergency services and calling the fire and rescue service.

7.4 Fire safety training

Staff training

The actions of staff if there is a fire are likely to be crucial to their safety and that of other people in the premises. All staff should receive basic fire safety induction training and attend refresher sessions at pre-determined intervals to maintain their level of knowledge and competence for the roles and duties they undertake for the fire safety arrangements of the premises.

You should ensure that all staff and contractors are told about the emergency plan and are shown the escape routes.

The training should take account of the findings of the fire risk assessment and be easily understood by all those attending. It should include the role that those members of staff will be expected to carry out if a fire occurs. This may vary in large premises, with some staff being appointed as emergency evacuation wardens or being given some other particular role for which additional training will be required.

In addition to the guidance given in Part 1, Step 4.4, as a minimum all staff should receive training about:

- the items listed in your emergency plan;
- the importance of fire doors and other basic fire-prevention measures;
- where relevant, the appropriate use of firefighting equipment;
- the importance of reporting to the assembly area;
- exit routes and the operation of exit devices, including physically walking these routes;
- general matters such as permitted smoking areas or restrictions on cooking other than in designated areas; and
- assisting disabled persons where necessary.

Training is necessary:

- when staff start employment or are transferred into the premises;
- when changes have been made to the emergency plan and/or the preventive and protective measures;
- where working practices and processes or people's responsibilities change;

- to take account of any changed risks to the safety of staff or other relevant persons;
- to ensure that staff know what they have to do to safeguard themselves and others on the premises;
- where staff are expected to assist disabled persons; and
- if a member of staff may take on the role of duty manager.

Training should be repeated as often as necessary and should take place during working hours.

Whatever training you decide is necessary to support your fire safety strategy and emergency plan, it should be verifiable.

Enforcing authorities may want to examine records as evidence that adequate training has been given.

Where safety personnel from an outside agency are on duty, it is your responsibility to ensure that such personnel have been trained to carry out the duties and responsibilities assigned to them.

Individuals who do not form a recognised part of the safety management structure (such as some security guards, hospitality staff, ground staff and commissionaires) should not be counted among the safety staff. You should ensure that such staff are given a general safety briefing on the means of escape, evacuation procedures and safety equipment.

Fire marshals and others with responsibilities for supervision and control in the event of a fire

Staff designated to undertake the role of fire marshals (often called fire wardens) would require more comprehensive training. Their role may include:

- helping those on the premises to leave;
- checking the premises to ensure everyone has left;
- using firefighting equipment if safe to do so;
- liaising with the fire and rescue service on arrival;
- shutting down vital or dangerous equipment; and
- performing a supervisory/managing role in any fire situation.

Training for this role may include:

- detailed knowledge of the fire safety strategy of the premises;
- awareness of human behaviour in fires;
- how to encourage others to use the most appropriate escape route;
- how to search safely and recognise areas that are unsafe to enter;
- the difficulties that some people, particularly if disabled, may have in escaping and any special evacuation arrangements that have been pre-planned;
- additional training in the use of firefighting equipment (if appropriate for your premises);
- an understanding of the purpose of any fixed firefighting equipment such as sprinklers or gas flooding systems; and
- reporting of faults, incidents and near misses.

Fire drills

Once the emergency plan has been developed and training given, you will need to evaluate its effectiveness. The best way to do this is to perform a fire drill. This should be carried out at least annually, or as determined by your fire risk assessment, and form part of your training programme. You should give particular consideration to the need for shift workers, contractors, etc. to be involved and to the level of staff turnover to ensure that all staff receive this type of training at appropriate intervals.

A well-planned and executed fire drill will confirm understanding of the training and provide helpful information for future training. The responsible person should determine the possible objectives of the drill, such as to:

- identify any weaknesses in the evacuation strategy;
- test the procedure following any recent alteration or changes to working practices;
- familiarise new members of staff with procedures; and
- test the arrangements for disabled people.

Who should take part?

Within each building the evacuation should include all occupants except those who may need to ensure the security of the premises, or people who, on a risk-assessed basis, are required to remain with particular equipment or processes that cannot be closed down.

Premises that consist of several buildings on the same site should be dealt with one building at a time over an appropriate period, unless the emergency procedure dictates otherwise.

Unless members of the public are included in your fire drills, the drill is unlikely to provide a reasonable test of your fire safety arrangements.

Carrying out the drill

For premises that have more than one escape route, the escape plan should be designed to evacuate all people on the assumption that one exit or stairway is unavailable because of the fire. This could be simulated by a designated person being located at a suitable point on an exit route. Applying this scenario to different escape routes at each fire drill will encourage individuals to use alternative escape routes which they may not normally use.

When carrying out the drill you might find it helpful to:

- circulate details concerning the drill and inform all staff of their duty to participate. It may not be beneficial to have 'surprise drills' as the health and safety risks introduced may outweigh the benefits;
- ensure that equipment can be left safely;
- nominate observers;
- inform the alarm receiving centre if the fire-warning system is monitored (if the fire and rescue service is normally called directly from your premises, ensure that this does not happen);
- inform visitors and members of the public if they are present; and
- ask a member of staff at random to set off the alarm by operating the nearest alarm call point using the test key. This will indicate the level of knowledge regarding the location of the nearest call point.

More detailed information on fire drills and test evacuations is given in BS 5588-12.¹⁵

The roll call/checking the premises have been evacuated

Carry out a roll call of your staff at the designated assembly point(s) as soon as possible and/or receive reports from wardens designated to 'sweep' the premises. You should note any people who are unaccounted for. In a real evacuation this information will need to be passed to the fire and rescue service on their arrival.

Check that people have assembled at the evacuation point.

Once the roll call is complete or all reports have been received, allow people to return to the building. If the fire-warning system is monitored, inform the alarm receiving centre that the drill has now been completed and record the outcomes of the drill.

Monitoring and debrief

Throughout the drill the responsible person and nominated observers should pay particular attention to:

- communication difficulties with regard to the roll call and establishing that everyone is accounted for;
- the use of the nearest available escape routes as opposed to common circulation routes;
- difficulties with the opening of final exit doors;
- difficulties experienced by people with disabilities;
- the roles of specified people, e.g. fire wardens;
- inappropriate actions, e.g. stopping to collect personal items, attempting to use lifts; and
- windows and doors not being closed as people leave.

On-the-spot debriefs are useful to discuss the fire drill, encouraging feedback from everybody. Later, reports from the fire wardens and observations from people should be collated and reviewed. Any conclusions and remedial actions should be recorded and implemented.

Section 8 Quality assurance of fire protection equipment and installation

Fire-protection products and related services should be fit for purpose and properly installed and maintained in accordance with the manufacturer's instructions or the relevant British Standard.

Third-party certification schemes for fire-protection products and related services are an effective means of providing the fullest possible assurances, offering a level of quality, reliability and safety that non-certificated products may lack. This does not mean goods and services that are not third-party approved are less reliable, but there is no obvious way in which this can be demonstrated.

Third-party quality assurance can offer comfort both as a means of satisfying you that the goods and services you have purchased are fit for purpose, and as a means of demonstrating that you have complied with the law.

However, to ensure the level of assurance offered by third-party schemes, you should always check whether the company you employ sub-contracts work to others. If they do, you will want to check that the sub-contractors are subject to the same level of checks of quality and competence as the company you are employing.

Your local fire and rescue service, fire trade associations or your own trade association may be able to provide further details about third-party quality assurance schemes and the various organisations that administer them.

Appendix A

A1 Example fire safety maintenance checklist

A fire safety maintenance checklist can be used as a means of supporting your fire safety policy. The list is not intended to be comprehensive and should not be used as a substitute for carrying out a fire risk assessment.

You can modify the example, where necessary, to fit your premises and you may need to incorporate the recommendations of manufacturers

and installers of the fire safety equipment/systems that you may have installed in your premises.

Any ticks in the grey boxes should result in further investigation and appropriate action as necessary. In larger and more complex premises you may need to seek the assistance of a competent person to carry out some of the checks.

	Yes	No	N/A	Comments
Daily checks (not normally recorded)				
Escape routes				
Can all fire exits be opened immediately and easily?	<input type="checkbox"/>	<input type="checkbox"/>	<input type="checkbox"/>	
Are fire doors clear of obstructions?	<input type="checkbox"/>	<input type="checkbox"/>	<input type="checkbox"/>	
Are escape routes clear?	<input type="checkbox"/>	<input type="checkbox"/>	<input type="checkbox"/>	
Fire warning systems				
Is the indicator panel showing 'normal'?	<input type="checkbox"/>	<input type="checkbox"/>	<input type="checkbox"/>	
Are whistles, gongs or air horns in place?	<input type="checkbox"/>	<input type="checkbox"/>	<input type="checkbox"/>	
Escape lighting				
Are luminaires and exit signs in good condition and undamaged?	<input type="checkbox"/>	<input type="checkbox"/>	<input type="checkbox"/>	
Is emergency lighting and sign lighting working correctly?	<input type="checkbox"/>	<input type="checkbox"/>	<input type="checkbox"/>	
Firefighting equipment				
Are all fire extinguishers in place?	<input type="checkbox"/>	<input type="checkbox"/>	<input type="checkbox"/>	
Are fire extinguishers clearly visible?	<input type="checkbox"/>	<input type="checkbox"/>	<input type="checkbox"/>	
Are vehicles blocking fire hydrants or access to them?	<input type="checkbox"/>	<input type="checkbox"/>	<input type="checkbox"/>	
Weekly checks				
Escape routes				
Do all emergency fastening devices to fire exits (push bars and pads, etc.) work correctly?	<input type="checkbox"/>	<input type="checkbox"/>	<input type="checkbox"/>	
Are external routes clear and safe?	<input type="checkbox"/>	<input type="checkbox"/>	<input type="checkbox"/>	
Fire warning systems				
Does testing a manual call point send a signal to the indicator panel? (Disconnect the link to the receiving centre or tell them you are doing a test.)	<input type="checkbox"/>	<input type="checkbox"/>	<input type="checkbox"/>	
Did the alarm system work correctly when tested?	<input type="checkbox"/>	<input type="checkbox"/>	<input type="checkbox"/>	
Did staff and other people hear the fire alarm?	<input type="checkbox"/>	<input type="checkbox"/>	<input type="checkbox"/>	
Did any linked fire protection systems operate correctly? (e.g. magnetic door holder released, smoke curtains drop)	<input type="checkbox"/>	<input type="checkbox"/>	<input type="checkbox"/>	

	Yes	No	N/A	Comments
Weekly checks <i>continued</i>				
Do all visual alarms and/or vibrating alarms and pagers (as applicable) work?	<input type="checkbox"/>	<input type="checkbox"/>	<input type="checkbox"/>	
Do voice alarm systems work correctly? Was the message understood?	<input type="checkbox"/>	<input type="checkbox"/>	<input type="checkbox"/>	
Escape lighting				
Are charging indicators (if fitted) visible?	<input type="checkbox"/>	<input type="checkbox"/>	<input type="checkbox"/>	
Firefighting equipment				
Is all equipment in good condition?	<input type="checkbox"/>	<input type="checkbox"/>	<input type="checkbox"/>	
Additional items from manufacturer's recommendations.	<input type="checkbox"/>	<input type="checkbox"/>	<input type="checkbox"/>	
Monthly checks				
Escape routes				
Do all electronic release mechanisms on escape doors work correctly? Do they 'fail safe' in the open position?	<input type="checkbox"/>	<input type="checkbox"/>	<input type="checkbox"/>	
Do all automatic opening doors on escape routes 'fail safe' in the open position?	<input type="checkbox"/>	<input type="checkbox"/>	<input type="checkbox"/>	
Are fire door seals and self-closing devices in good condition?	<input type="checkbox"/>	<input type="checkbox"/>	<input type="checkbox"/>	
Do all roller shutters provided for fire compartmentation work correctly?	<input type="checkbox"/>	<input type="checkbox"/>	<input type="checkbox"/>	
Are external escape stairs safe?	<input type="checkbox"/>	<input type="checkbox"/>	<input type="checkbox"/>	
Do all internal self-closing fire doors work correctly?	<input type="checkbox"/>	<input type="checkbox"/>	<input type="checkbox"/>	
Escape lighting				
Do all luminaires and exit signs function correctly when tested?	<input type="checkbox"/>	<input type="checkbox"/>	<input type="checkbox"/>	
Have all emergency generators been tested? (Normally run for one hour.)	<input type="checkbox"/>	<input type="checkbox"/>	<input type="checkbox"/>	
Firefighting equipment				
Is the pressure in 'stored pressure' fire extinguishers correct?	<input type="checkbox"/>	<input type="checkbox"/>	<input type="checkbox"/>	
Additional items from manufacturer's recommendations.	<input type="checkbox"/>	<input type="checkbox"/>	<input type="checkbox"/>	
Three-monthly checks				
General				
Are any emergency water tanks/ponds at their normal capacity?	<input type="checkbox"/>	<input type="checkbox"/>	<input type="checkbox"/>	
Are vehicles blocking fire hydrants or access to them?	<input type="checkbox"/>	<input type="checkbox"/>	<input type="checkbox"/>	
Additional items from manufacturer's recommendations.	<input type="checkbox"/>	<input type="checkbox"/>	<input type="checkbox"/>	
Six-monthly checks				
General				
Has any firefighting or emergency evacuation lift been tested by a competent person?	<input type="checkbox"/>	<input type="checkbox"/>	<input type="checkbox"/>	
Has any sprinkler system been tested by a competent person?	<input type="checkbox"/>	<input type="checkbox"/>	<input type="checkbox"/>	
Have the release and closing mechanisms of any fire-resisting compartment doors and shutters been tested by a competent person?	<input type="checkbox"/>	<input type="checkbox"/>	<input type="checkbox"/>	
Fire warning system				
Has the system been checked by a competent person?	<input type="checkbox"/>	<input type="checkbox"/>	<input type="checkbox"/>	

	Yes	No	N/A	Comments
Six-monthly checks <i>continued</i>				
Escape lighting				
Do all luminaires operate on test for one third of their rated value?	<input type="checkbox"/>	<input type="checkbox"/>	<input type="checkbox"/>	
Additional items from manufacturer's recommendations.	<input type="checkbox"/>	<input type="checkbox"/>	<input type="checkbox"/>	
Annual checks				
Escape routes				
Do all self-closing fire doors fit correctly?	<input type="checkbox"/>	<input type="checkbox"/>	<input type="checkbox"/>	
Is escape route compartmentation in good repair?	<input type="checkbox"/>	<input type="checkbox"/>	<input type="checkbox"/>	
Escape lighting				
Do all luminaires operate on test for their full rated duration?	<input type="checkbox"/>	<input type="checkbox"/>	<input type="checkbox"/>	
Has the system been checked by a competent person?	<input type="checkbox"/>	<input type="checkbox"/>	<input type="checkbox"/>	
Firefighting equipment				
Has all firefighting equipment been checked by a competent person?	<input type="checkbox"/>	<input type="checkbox"/>	<input type="checkbox"/>	
Miscellaneous				
Has any dry/wet rising fire main been tested by a competent person?	<input type="checkbox"/>	<input type="checkbox"/>	<input type="checkbox"/>	
Has the smoke and heat ventilation system been tested by a competent person?	<input type="checkbox"/>	<input type="checkbox"/>	<input type="checkbox"/>	
Has external access for the fire service been checked for ongoing availability?	<input type="checkbox"/>	<input type="checkbox"/>	<input type="checkbox"/>	
Have any firefighters' switches been tested?	<input type="checkbox"/>	<input type="checkbox"/>	<input type="checkbox"/>	
Has the fire hydrant bypass flow valve control been tested by a competent person?	<input type="checkbox"/>	<input type="checkbox"/>	<input type="checkbox"/>	
Are any necessary fire engine direction signs in place?	<input type="checkbox"/>	<input type="checkbox"/>	<input type="checkbox"/>	

Appendix A

A2 Example form for recording significant findings

Risk Assessment – Record of significant findings		
Risk assessment for		Risk assessment by
Company		Date
Facility		Completed by
Address		Signature
Sheet number	Location	Use
Step 1 – Identify fire hazards		
Sources of ignition	Sources of fuel	Sources of oxygen
Step 2 – People at risk		
People at risk	Special risks	
Number of people in gate room		
Passengers		
Staff and accompanied visitors		
Step 3 – Evaluate, remove, reduce and protect from risk		
Existing fire precautions		
Evaluation of the likelihood of a fire occurring		
Evaluation of the risk to people from a fire occurring		
Removal or reduction of the fire hazards		
Step 4 – Record, plan, inform, instruct and train		
Significant finding		
Actions required	Delivery dates	Action owner/date completed
Emergency plans		
Inform, instruct, co-operate and co-ordinate		
Fire safety training		
Step 5 – Review		
Assessment review date	Completed by	Signature

Appendix B

Technical information on fire-resisting separation, fire doors and door fastenings

B1 Fire-resisting separation

General

The materials from which your premises are constructed may determine the speed with which a fire may spread, affecting the escape routes that people will use. A fire starting in a building constructed mainly from readily combustible material will spread faster than one where modern fire-resisting construction materials have been used. Where non-combustible materials are used and the internal partitions are made from fire-resisting materials, the fire will be contained for a longer period, allowing more time for the occupants to escape.

Because of the requirements of the building regulations you will probably already have some walls, floors and ceilings that are fire-resisting and limitations on the surface finishes to certain walls and ceilings.

You will need to consider whether the standard of fire resistance and surface finishing in the escape routes is satisfactory, has been affected by wear and tear or alterations and whether any improvements are necessary.

The following paragraphs give basic information on how fire-resisting construction can provide up to 30 minutes' protection to escape routes. This is the standard recommended for most situations. However, for basements, other underground rooms and sub-surface railway stations, 60 minutes' protection is recommended. If you are unsure of the level of fire resistance which is necessary after reading this information, you should consult a fire safety expert.

Fire-resisting construction

The fire resistance of a wall or floor is dependent on the quality of construction and materials used. Common examples of types of construction that provide 30-minute fire resistance to escape routes if constructed to the above standards are:

- internal framed construction wall, non-load bearing, consisting of 72mm x 37mm timber studs at 600mm centres and faced with 12.5mm of plasterboard with all joints taped and filled (see Figure 72);

Figure 72: Fire-resisting construction

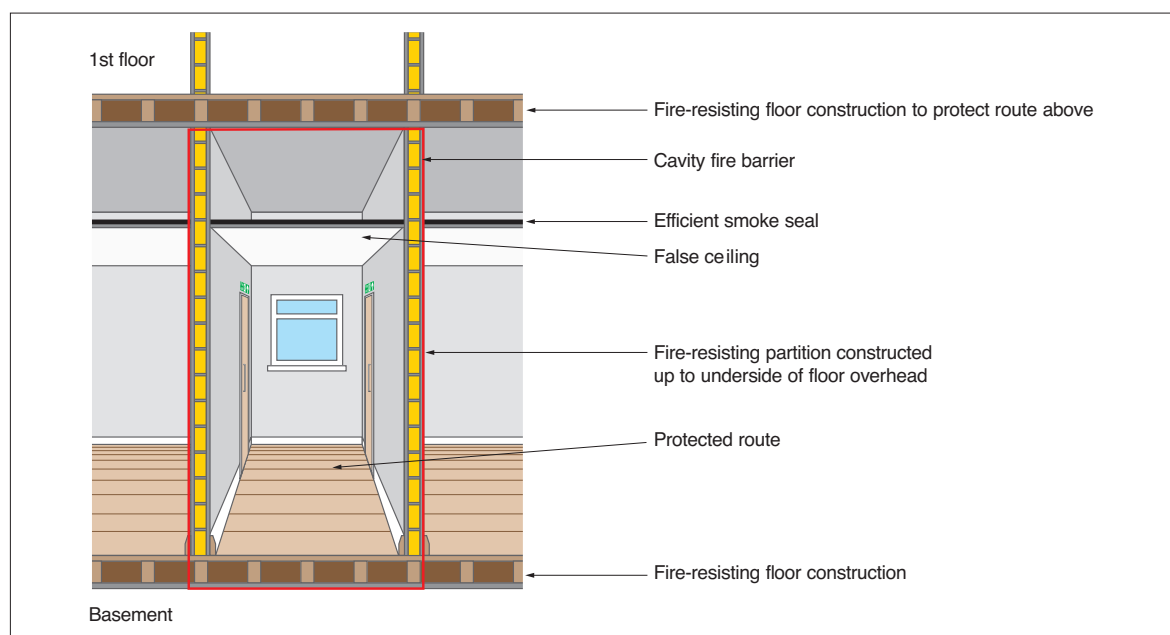

- internal framed construction, non-load bearing, consisting of channel section steel studs at 600mm centres faced with 12.5mm of plasterboard with all joints taped and filled; and
- masonry cavity wall consisting of solid bricks of clay, brick earth, shale, concrete or calcium silicate, with a minimum thickness of 90mm on each leaf.

There are other methods and products available which will achieve the required standard of fire resistance and may be more appropriate for the existing construction in your premises. If there is any doubt about how your building is constructed, then ask for further advice from a competent person.

Fire-resisting floors

The fire resistance of floors will depend on the existing floor construction as well as the type of ceiling finish beneath. If you need to upgrade the fire resistance of your floor it may not be desirable to apply additional fire resistance to the underside of an existing ornate ceiling. In older buildings there may be a requirement to provide fire resistance between beams and joists.

A typical example of a 30-minute fire-resisting timber floor is tongue and groove softwood of not less than 15mm finished thickness on 37mm timber joists, with a ceiling below of one layer of plasterboard to a thickness of 12.5mm with joints taped and filled and backed by supporting timber.

There are other, equally valid, methods and products available for upgrading floors. If you are in any doubt you should ask the advice of a competent person and ensure that the product is installed in accordance with instructions from the manufacturer or supplier.

Fire-resisting glazing

The most common type of fire-resisting glazing is 6mm Georgian wired glazing, which is easily identifiable. Clear fire-resisting glazing is available and can quickly be identified by a mark etched into the glass, usually in the corner of the glazed panel, to confirm its fire-resisting standard. Although this is not compulsory, the marking of glass is supported by the Glass and Glazing Federation; you should check whether the glazing will be marked accordingly before purchase. The glazing should have been installed in accordance with the manufacturer's instructions and to the appropriate standard,⁶⁰ to ensure that its fire-resisting properties are maintained.

The performance of glazed systems in terms of fire resistance and external fire exposure should, wherever possible, be confirmed by test evidence. Alternatively, where there is a lack of test information, ask for an assessment of the proposed construction from suitably qualified people.

Fire separation of voids

A common problem encountered with fire separation is fire-resisting partitions which do not extend above false ceilings to true ceiling height. This may result in unseen fire spread and a loss of vital protection to the escape routes. It is important, therefore, to carefully check that all such partitions have been installed correctly.

Breaching fire separation

To ensure effective protection against fire, walls and floors providing fire separation must form a complete barrier, with an equivalent level of fire resistance provided to any openings such as doors, ventilation ducts, pipe passages or refuse chutes.

The passing of services such as heating pipes or electrical cables through fire-resisting partitions leaves gaps through which fire and smoke may spread. This should be rectified by suitable fire stopping and there are many proprietary products available to suit particular types of construction. Such products should be installed by competent contractors.

Décor and surface finishes of walls, ceilings and escape routes

The materials used to line walls and ceilings can contribute significantly to the spread of flame across their surface. Most materials that are used as surface linings will fall into one of three classes of surface spread of flame. The following are common examples of acceptable materials for various situations:

- **Class 0: Materials suitable for circulation spaces and escape routes**

Such materials include brickwork, blockwork, concrete, ceramic tiles, plaster finishes (including rendering on wood or metal lathes), wood-wool cement slabs and mineral fibre tiles or sheets with cement or resin binding.

Note 1: Additional finishes to these surfaces may be detrimental to the fire performance of the surface and if there is any doubt about this then consult the manufacturer of the finish.

Note 2: For sub-surface stations and facilities, continued use of non-Class 0 material should be justified through risk assessment and risk mitigation measures.

- **Class 1: Materials suitable for use in all rooms but not on escape routes**

Such materials include all the Class 0 materials referred to above. Additionally, timber, hardboard, blockboard, particle board, heavy flock wallpapers and thermosetting plastics will be suitable if flame-retardant treated to achieve a Class 1 standard.

- **Class 3: Materials suitable for use in rooms of less than 30m²**

Such materials include all those referred to in Class 1, including those that have not been flame-retardant treated, and certain dense timber or plywood and standard glass-reinforced polyesters.

The equivalent European classification standard will also be acceptable. Further details about internal linings and classifications are available in the Building Regulations Approved Document B.⁴⁶ Appropriate testing procedures are detailed in BS 476-7⁶¹ and, where appropriate, BS EN 13501-1.⁶²

Further guidance on types of fire-resisting construction has been published by the Building Research Establishment.⁶³

B2 Fire-resisting doors

Requirements of a fire-resisting door

Effective fire-resisting doors (see Figure 73) are vital to ensure that the occupants can evacuate to a place of safety. Correctly specified and well-fitted doors will hold back fire and smoke, preventing escape routes becoming unusable, as well as preventing the fire spreading from one area to another.

Figure 73: A fire-resisting and smoke stopping door

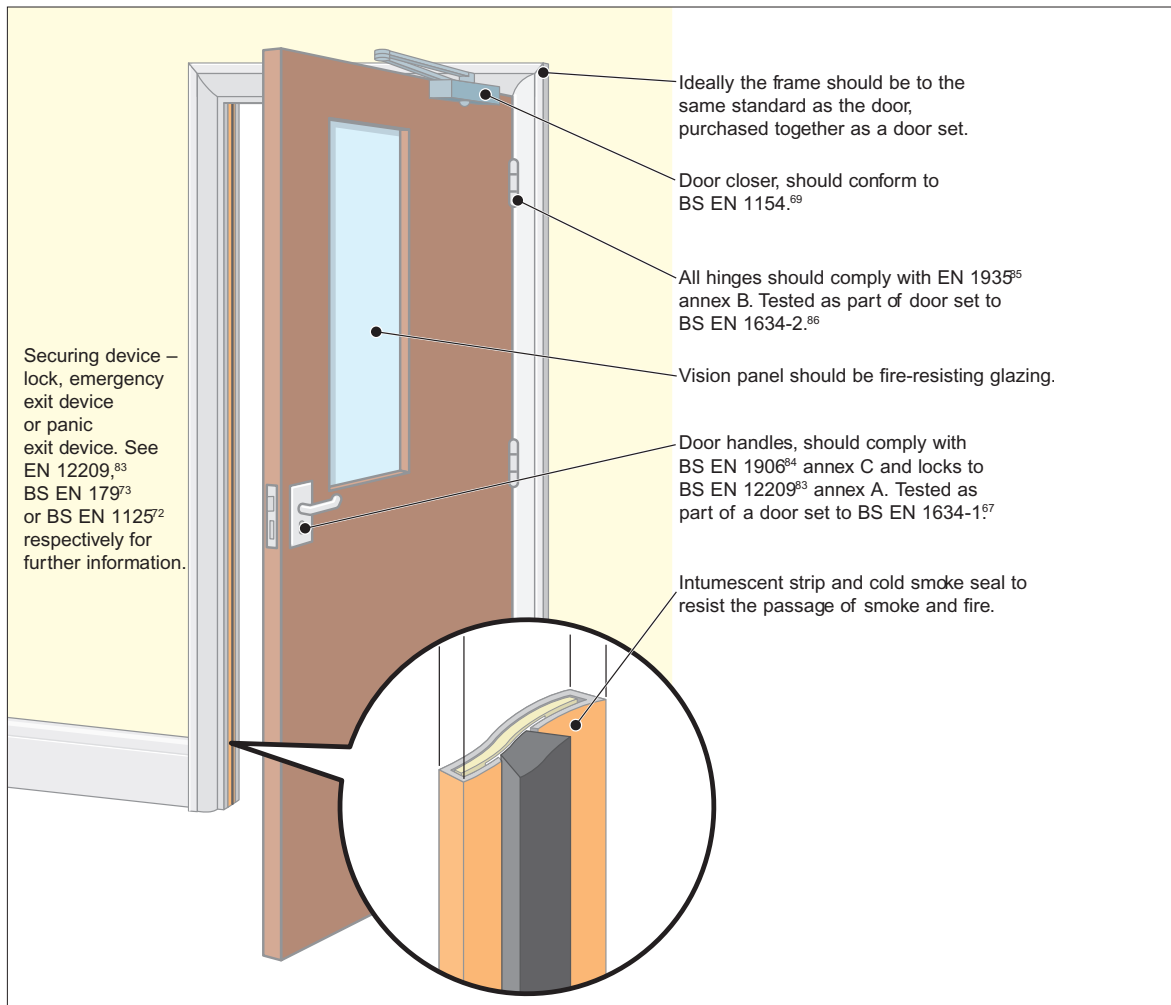

Fire-resisting doors are necessary in any doorway located in a fire-resisting structure. Most internal doors are constructed of timber. These will give some limited protection against fire spread, but only a purpose-built fire-resisting door that has been tested to an approved standard will provide the necessary protection. Metal fire-resisting doors are also available and specific guidance for these follows.

All fire-resisting doors are rated by their performance when tested to an appropriate standard. The level of protection provided by the door is measured, primarily by determining the time taken for a fire to breach the integrity (E), of the door assembly, together with its resistance to the passage of hot gases and flame.

It may be possible to upgrade the fire resistance of existing doors. Further information is available from the Building Research Establishment⁶⁴ or Timber Research and Development Association.⁶⁵

Timber fire-resisting doors require a gap of 2–4mm between the door leaf and the frame. However, larger gaps may be necessary to ensure that the door closes flush into its frame when smoke seals are fitted. Further information is available in BS 4787-1.⁶⁶ For fire-resisting purposes the gap is normally protected by installing an intumescent seal, in either the door or, preferably, the frame. The intumescent seal expands in the early stages of a fire and enhances the protection given by the door. Additional smoke seals will restrict the spread of smoke at ambient temperatures. Doors fitted with smoke seals, either incorporated in the intumescent seal or fitted separately, have their classification code suffixed with an 'S'.

The principal fire-resisting door categories are:

- E20 fire-resisting door providing 20 minutes fire resistance (or equivalent FD 20S). (Note: Many suppliers no longer provide an E20-type fire-resisting door.)
- E30 fire-resisting door providing 30 minutes fire resistance (or equivalent FD 30S).
- E60 fire-resisting door providing 60 minutes fire resistance (or equivalent FD 60S).

Timber fire-resisting doors are available that will provide up to 120 minutes fire resistance but their use is limited to more specialised conditions that are beyond the scope of this guidance.

Metal fire-resisting doors

Although the majority of fire-resisting doors are made from timber, metal fire-resisting doors, which meet the appropriate standard, can often be used for the same purpose. However, there are situations where they are more appropriate. The majority of metal fire-resisting door manufacturers will require the use of bespoke frames and hardware for their door sets.

See BS EN 1634-1,⁶⁷ and BS 476-22⁶⁸ for more information.

For detailed guidance, refer to the Building Regulations Approved Document B.⁴⁶

Glazing in fire-resisting doors

Although glazing provides additional safety in everyday use and can enhance the appearance of fire-resisting doors, it should never reduce the fire resistance of the door. The opening provided in the door for the fire-resisting glazing unit(s) and the fitting of the beading are critical, and should only be entrusted to a competent person. In nearly all cases the door and glazing should be purchased from a reputable supplier who can provide documentary evidence that the door continues to achieve the required rating.

Fire-resisting door furniture

Hinges

To ensure compliance with their rated fire performance, fire-resisting doors need to be hung with the correct number, size and quality of hinges. Normally a minimum of three hinges are needed; however, the manufacturer's instructions should be closely followed. BS EN 1935,⁸⁵ including Annex B, is the appropriate standard.

Alternative door mountings

Although the most common method of hanging a door is to use single axis hinges, alternative methods are employed where the door is required to be double swing or mounted on pivots for other reasons.

Floor-mounted controlled door-closing devices are the most common method regularly found with timber, glass and steel doors, while transom-mounted devices are commonly used with aluminium sections. In each case reference should be made to the fire test report for details as to compliance with the composition of the door assembly, including the door-mounting conditions.

Self-closing devices

All fire-resisting doors, other than those to locked cupboards and service ducts, should be fitted with an appropriately controlled self-closing device that will effectively close the door from any angle. In certain circumstances, concealed, jamb-mounted closing devices may be specified and in these cases should be capable of closing the door from any angle and against any latch fitted to the door; spring hinges are unlikely to be suitable. Further information is available in BS EN 1154.⁶⁹

Rising butt hinges are not suitable for use as a self-closing device due to their inability to close and latch the door from any angle.

Automatic door hold-open/release devices for self-closing fire doors

These devices are designed to hold open self-closing fire doors or allow them to swing free during normal use. In the event of a fire alarm the device will then release the door automatically, allowing the self-closing mechanism to close the door.

Such devices are particularly useful in situations where self-closing doors on escape routes are used regularly by significant numbers of people, or by people with impaired mobility who may have difficulty in opening the doors.

Typical examples of such devices include:

- electro-magnetic devices fitted to the fire-resisting door which release when the fire-detection and warning system operates, allowing a separate self-closer to close the door;
- electro-magnetic devices within the controlled door-closing device which function on the operation of the fire-detection and warning system; and
- 'free swing' controlled door-closing devices, which operate by allowing the door leaf to work independently of the closing device in normal conditions. An electro-magnetic device within the spring mechanism linked to the fire-detection and warning system ensures that the door closes on the operation of the system.

Note: Free swing devices may not be suitable in some situations, such as corridors, where draughts are a problem and the doors are likely to swing uncontrolled, causing possible difficulty or injury to certain people, e.g. those with certain disabilities, the elderly and frail, or young children.

Automatic door hold-open/release devices fitted to doors protecting escape routes should only be installed in conjunction with an automatic fire-detection and warning system incorporating smoke detectors, which is designed to protect the escape routes in the building (see Part 2, Section 2).

In all cases the automatic device should release the fire-resisting door, allowing it to close effectively within its frame when any of the following conditions occur.

- the detection of smoke by an automatic detector;
- the actuation of the fire-detection and alarm system by manual means, e.g. operation of break-glass call point;
- any failure of the fire-detection and alarm system; or
- any electrical power failure.

Other devices, including self-contained devices which perform a similar function, that are not connected directly to a fire alarm system and are therefore not able to meet the above criteria are available and may be acceptable where a site-specific risk assessment can show that they are appropriate. Such devices are unlikely to be suitable for use on doors protecting single stairways or other critical means of escape.

In all cases where a door hold-open device is used it should be possible to close the door manually.

A site-specific risk assessment should be undertaken before any type of automatic door hold-open/release device is installed. If you are unsure about the suitability of such devices in your premises, you should seek the advice of a competent person.

Further guidance about automatic door hold-open/release devices is given in BS EN 1155⁷⁹ or BS 5839-3⁸⁰.

Door co-ordinators

Where pairs of doors with rebated meeting stiles are installed, it is critical that the correct closing order is maintained. Door co-ordinators to BS EN 1158⁷⁰ should be fitted and fully operational in all cases where the doors are self-closing.

Installation and workmanship

The reliability and performance of correctly specified fire-resisting doors can be undermined by inadequate installation. It is important that installers with the necessary level of skill and knowledge are used. Accreditation schemes for installers of fire-resisting doors are available.

Fire-resisting doors and shutters will require routine maintenance, particularly to power operation and release and closing mechanisms.

Further information is available on fire-resisting doors in BS 8214.⁷¹ If you are unsure about the quality, the effectiveness or the fitting of your fire-resisting doors consult a fire safety expert.

For further guidance on the selection and maintenance of door furniture suitable for use on timber fire-resisting and escape doors refer to the Building Hardware Industry Federation (BHIF) Code of Practice – Hardware for Timber Fire and Escape Doors⁸². DHF (Door and Hardware Federation) and GAI (Guild of Architectural Ironmongers).

B3 Door-fastening devices

The relationship between the securing of doors against unwanted entry and the ability to escape through them easily in an emergency has often proved problematical. Careful planning and the use of quality materials remain the most effective means of satisfying both of these objectives.

Any device that impedes people making good their escape, either by being unnecessarily complicated to manipulate or by not being readily openable, will not be acceptable.

Guidance on fire exits starts from the position that doors on escape routes should not be fitted with any locking devices (electrically operated or otherwise). However, it is accepted that in many cases the need for security will require some form of device that prevents unlimited access, but still enables the occupants of a building or area to open the door easily if there is a fire. These devices can take many forms but, in the majority of cases, premises where there are members of the public present or others who are not familiar with the building should use panic bar devices (e.g. push bars or touch bars). See BS EN 1125⁷² for further information.

Premises that have limited numbers of staff or others who are familiar with the building and where panic is not likely may use alternative devices (i.e. push pads or lever handles). See BS EN 179⁷³ for further information.

In some larger premises, when only certain staff are on the premises and there is a security issue, it may be acceptable to restrict the number of emergency exits immediately available, e.g. when only security staff are present at night or prior to opening the premises in the morning. Staff should be made fully aware of any restrictions and the number of exits not immediately available should be limited.

Electrical locking devices

Electrically operated entry control devices have been developed for use as locking devices on fire exits. They fall into two main categories, electromechanical and electromagnetic.

- Electromechanical devices

Electromechanical devices comprise electromechanical lock keeps and draw bolts, which can be controlled by people inside the premises by entering a code or by using 'smart cards', which have been adapted to control the exit from certain areas. These devices have been fitted in many premises and may be linked to the fire-detection and/or warning system. Experience has shown that these devices can fail to open in a number of ways. They are dependent on a spring mechanism to return the lock keep or draw bolt(s) and are liable to jam when pressure is applied to the door. It is also relatively easy to fit them incorrectly. Electromechanical locking devices are normally unacceptable on escape doors, unless they are fitted with a manual means of overriding the locking mechanism, such as a push bar, push pad or lever handle, or they do not rely on a spring mechanism, fail-safe open and are not affected by pressure, in which case the criteria for electromagnetic devices should be applied.

- Electromagnetic devices

These devices comprise a magnet and a simple fixed retaining plate with no moving parts and are therefore generally considered to be more reliable due to their inherent 'fail-safe unlocked' operation. Electromagnetic locking devices go some way to addressing the particular concerns

surrounding electromechanical locking systems. The release of this type of device is controlled by the interruption of electrical current to an electromagnet either manually via a switch or other means, break-glass point (typically coloured green), or by linking to the fire-warning and/or detection system of the premises.

Time-delay devices on escape routes

A further development is the fitting of a time-delay system to the electronic door-locking device. This delays the actual opening of an exit door for a variable period following operation of the panic bar or other exit device. Periods of between 5 and 60 seconds can be pre-set at the manufacturing stage or can be adjusted when fitted. These are not usually acceptable for use by members of the public. However, they may be acceptable for use by staff who are familiar with their operation and are suitably trained in their use.

Management of electronic door-control devices including time delays

The use of such devices may be accepted by enforcing authorities if the responsible person can demonstrate, through a suitable risk assessment for each individual door, both the need and the adequate management controls to ensure that people can escape safely from the premises. In particular:

- Access control should not be confused with exit control. Many devices are available which control the access to the premises but retain the immediate escape facility from the premises.
- In public areas, when push bars are operated on escape doors, they should release the electromagnetic locks immediately and allow the exit doors to open.
- The requirement for exit control should be assessed carefully and should not be seen as a substitute for good management of the employees and occupants.
- All other alternatives should have been explored/evaluated prior to using these devices to ensure they do not affect the safety of occupants.
- The device should be connected to the fire-warning and/or detection system.
- The device should incorporate a bypass circuit for immediate release on activation of the fire-warning and/or detection system.

- Each door should be fitted with a single securing device.
- The emergency exit doors should be clearly labelled about how to operate them.
- Adequate control measures should be put in place to ensure the safety of the occupants.

The use of electronic door-locking devices should be considered with particular care in premises with a number of different occupancies. The management of a complicated system of evacuation for many different groups is unlikely to be practicable.

The technical standards in respect of sourcing, maintaining and testing must be extremely high.

When part of the management control system involves trained personnel helping others at these doors, it is vital to ensure that these people are available.

The use of exit control devices should not be considered where the number of trained staff is low or where members of the public would be expected to operate the devices without help.

In premises where there may be large numbers of people, the devices should only be considered when linked to a comprehensive automatic fire-detection and warning system in accordance with BS 5839-1.³⁵ There should be an additional means of manually overriding the locking device at each such exit (typically a green break-glass point).

The use of time-delay systems that prevent the opening of emergency exits for a pre-set time are primarily used to improve security. These add a further layer of complexity to the fire strategy and should not be considered in public areas. They should only be used in non-public areas when all other options such as relocating valuable stock or exterior boundary management have been addressed. Their value in preventing theft is likely to be transient as the use of the manual override becomes more widely known.

BS 8220-3⁷⁴ gives further advice on security in buildings and, while this standard does refer to electronic locking devices, it also acknowledges that the balance must remain on the side of emergency escape rather than security.

Appendix C

Historic buildings

General considerations

This appendix offers additional information about listed and historical buildings.

Fire risk assessments conducted for a transport facility which is within a listed or historic building will need to endeavour to strike a balance between ensuring that sufficient fire safety measures are in place for the safety of people, yet avoid extensive alterations and help maintain the character of the building.

As well as the fire risk assessment, it is recommended that a general fire policy statement and manual is compiled. A person must be nominated to take responsibility for all aspects of fire safety. Usually, the person charged with the management and control of the premises will be the 'responsible person' under the Order.¹

The advice and/or consent of a building control body or any other relevant bodies (e.g. English Heritage) should form part of any fire risk assessment that impacts on the character of the building (e.g. replacement of doors, fittings, wooden panelling and décor) or material changes to existing escape routes. An ideal solution is one that is reversible, enabling the historic elements to be reinstated.

A fire safety adviser will be able to suggest alternatives to conventional fire precautions, such as:

- a fire engineering solution;
- upgrading existing doors and partitions in a sympathetic manner to improve their fire resistance; and
- considering the installation of specialist fire-detection or suppression systems.

Should the design and nature of the historic building preclude the introduction of conventional fire safety features, it will be necessary to manage the building in such a way that:

- limits the number of occupants, either staff or members of the public, inside the building;
- limits activities in the building; and

- provides adequate supervision within the building.

Liaison with the fire and rescue service

The responsible person will need to ensure effective liaison with the fire and rescue service to enable them to carry out firefighting operations. These may include information on:

- the provision of water supplies, seasonal ponds, lakes, underground tanks, and any associated pumps;
- difficult access for fire engines;
- particular hazards in the construction features of the building (including asbestos);
- the use of combustible under-floor insulation;
- underground vaults, ducts and voids where fire may spread unchecked;
- worn stone slabs in stairway construction; and
- the presence of cast iron columns and wrought iron beams.

Emergency planning

An important consideration for the owners and trustees is the protection of valuable artefacts and paintings from the effects of fire. However, the efficient evacuation of all occupants must take precedence over procedures for limiting damage to property and contents. Salvage work should be limited to those parts of the building not directly affected by the fire.

Fire wardens and others tasked with carrying out salvage work should have received formal training, adequate protection and be fully briefed about the health and safety risk assessment carried out to identify the dangers associated with this activity. Further detailed advice on fire safety in historic buildings can be found in the following publications:

- BS 7913: Guide to the principles of the conservation of historic buildings, British Standards Institution
- Heritage under fire: A guide to the protection of historic buildings, Fire Protection Association (for the UK Working Party on Fire Safety in Historic Buildings) 1991, ISBN 0 902167 94 4

- The Installation of Sprinkler Systems in Historic Buildings (Historic Scotland Technical Advice Note S.), Fire Protection Association (TCRE Division/Scottish Conservation Bureau, Hist.) 1998, ISBN 1 900168 63 4
- Fire-protection Measures in Scottish Historic Buildings: Advice on Measures Required to Minimise the Likelihood of Fire Starting and to Alleviate the Destructive Consequences of Fire in Historic Buildings (Technical Advice Note), TCRE Division/Scottish Conservation Bureau, Hist. 1997, ISBN 1 900168 41 3
- Fire Risk Management in Heritage Buildings (Technical Advice Note), TCRE Division/Scottish Conservation Bureau, Hist. 2001, ISBN 1 900168 71 5
- Summary and conclusions of the report into fire-protection measures for the Royal Palaces by Sir Alan Bailey following the Windsor Castle fire, 1992.
- The fire at Upton Park, The National Trust.
- Timber panelled doors and fire, English Heritage.
- Fire safety in historic town centres, English Heritage and Cheshire Fire and Rescue Service.

Appendix D

Glossary

These definitions are provided to assist the responsible person in understanding some of the technical terms used in this guide. They are not exhaustive and more precise definitions may be available in other guidance.

Term	Definition
Access room	A room through which the only escape route from an inner room passes.
Accommodation stairway	A stairway, additional to that required for means of escape purposes, provided for the convenience of occupants.
Alterations notice	If your premises are considered by the enforcing authority to be high risk, they may issue an alterations notice that requires you to inform them before making any material alterations to your premises.
Alternative escape route	Escape routes sufficiently separated either by direction and space or by fire-resisting construction to ensure that one is still available irrespective of the location of a fire.
Approved Document B (ADB) ⁴⁶	Guidance issued by Government in support of the fire safety aspects of the building regulations.
As low as reasonably practicable	Is a concept where risks should continue to be reduced until you reach a point where the cost and effort to reduce the risk further would be grossly disproportionate to the benefit achieved.
Automatic fire detection system	A means of automatically detecting the products of a fire and sending a signal to a fire warning system. See 'Fire-warning system'.
Basement	A storey with a floor which at some point is more than 1,200mm below the highest level of ground adjacent to the outside walls, unless, and for escape purposes only, such an area has adequate, independent and separate means of escape.
Child	Anyone who is not over compulsory school age, i.e. before or just after their 16th birthday.
Class 0, 1 or 3 surface spread of flame	Classes of surface spread of flame for materials needed to line the walls and ceilings of escape routes. See Appendix B for further information.
Combustible material	A substance that can be burned.
Compartment wall and/or floor	A fire-resisting wall or floor that separates one fire compartment from another.
Competent person	A person with enough training and experience or knowledge and other qualities to enable them properly to assist in undertaking the preventative and protective measures.

Term	Definition
Dangerous substance	<p>1. A substance which because of its physico-chemical or chemical properties and the way it is used or is present at the workplace creates a risk.</p> <p>2. A substance subject to the Dangerous Substances and Explosive Atmospheres Regulations 2002 (DSEAR).</p>
Dead end	Area from which escape is possible in one direction only.
Direct distance	The shortest distance from any point within the floor area to the nearest storey exit, or fire-resisting route, ignoring walls, partitions and fixings.
Domestic premises	Premises occupied as a private dwelling, excluding those areas used in common by the occupants of more than one such dwelling.
Emergency escape lighting	Lighting provided to illuminate escape routes that will function if the normal lighting fails.
Enforcing authority	The fire and rescue authority or any other authority specified in Article 25 of the Regulatory Reform (Fire Safety) Order 2005. ¹
Escape route	Route forming part of the means of escape from any point in the premises to a final exit.
Evacuation lift	A lift that may be used for the evacuation of people with disabilities, or others, in a fire.
External escape stair	Stair providing an escape route, external to the building.
Fail-safe	Locking an output device with the application of power and having the device unlock when the power is removed. Also known as fail unlock, reverse action or power locked.
False alarm	A fire signal, usually from a fire warning system, resulting from a cause other than fire.
Final exit	An exit from a building where people can continue to disperse in safety and where they are no longer at danger from fire and/or smoke.
Fire compartment	A building, or part of a building, constructed to prevent the spread of fire to or from another part of the same building or an adjoining building.
Fire door	A door or shutter, together with its frame and furniture, provided for the passage of people, air or goods which, when closed, is intended to restrict the passage of fire and/or smoke to a predictable level of performance.
Firefighting lift	A lift, designed to have additional protection, with controls that enable it to be used under the direct control of the fire and rescue service when fighting a fire.
Firefighting shaft	A fire-resisting enclosure containing a firefighting stair, fire mains, firefighting lobbies and, if provided, a firefighting lift.

Term	Definition
Firefighting stairway	See firefighting shaft.
Fire resistance	The ability of a component or construction of a building to satisfy, for a stated period of time, some or all of the appropriate criteria of relevant standards. (Generally described as 30 minutes fire-resisting or 60 minutes fire-resisting.) See BS EN 1363-1, BS 476-7 ⁶¹ and associated standards for further information.
Fire safety manager	A nominated person with responsibility for carrying out day-to-day management of fire safety. (This may or may not be the same as the 'responsible person'.)
Fire safety strategy	A number of planned and co-ordinated arrangements designed to reduce the risk of fire and to ensure the safety of people if there is a fire.
Fire stopping	A seal provided to close an imperfection of fit or design tolerance between elements or components, to restrict the passage of fire and smoke.
Fire-warning system	A means of alerting people to the existence of a fire. (See 'Automatic fire detection system'.)
Flammable material	Easily ignited and capable of burning rapidly.
Hazardous substance	1. See 'Dangerous substance'. 2. A substance subject to the Control of Substances Hazardous to Health Regulations 2002 (COSHH).
Highly flammable	Generally liquids with a flashpoint of below 21°C. (The Chemicals (Hazard Information and Packaging for Supply) Regulations 2002 (CHIP) give more detailed guidance.)
Inner room	A room from which escape is possible only by passing through another room (the access room).
Licensed premises	Any premises that require a licence under any statute to undertake trade or conduct business activities.
Material change	An alteration to the premises, process or service which significantly affects the level of risk to people from fire in those premises.
Means of escape	Route(s) provided to ensure safe egress from the premises or other locations to a place of total safety.
Phased evacuation	A system of evacuation in which different parts of the premises are evacuated in a controlled sequence of phases, those parts of the premises expected to be at greatest risk being evacuated first.
Place of reasonable safety	A place within a building or structure where, for a limited period of time, people will have some protection from the effects of fire and smoke. This place, usually a corridor or stairway, will normally have a minimum of 30 minutes' fire resistance and allow people to continue their escape to a place of total safety.

Term	Definition
Place of total safety	A place, away from the premises, in which people are at no immediate danger from the effects of a fire.
Premises	Any place, such as a building and the immediate land bounded by any enclosure of it, any tent, moveable or temporary structure or any installation or workplace.
Protected lobby	A fire-resisting enclosure providing access to an escape stairway via two sets of fire doors and into which no room opens other than toilets and lifts.
Protected route	An escape route that is adequately protected from the rest of the building by fire-resisting construction.
Protected stairway	A stairway that is adequately protected from the rest of the building by fire-resisting construction.
Refuge	A place of reasonable safety in which a disabled person and others who may need assistance may rest or wait for assistance before reaching a place of total safety. It should lead directly to a fire-resisting escape route.
Relevant persons	Any person lawfully on the premises and any person in the immediate vicinity, but does not include firefighters carrying out firefighting duties.
Responsible person	The person ultimately responsible for fire safety as defined in the Regulatory Reform (Fire Safety) Order 2005. ¹
Self-closing device	A device that is capable of closing the door from any angle and against any latch fitted to the door.
Significant finding	<p>A feature of the premises, from which the fire hazards and persons at risk are identified.</p> <p>The actions you have taken or will take to remove or reduce the chance of a fire occurring or the spread of fire and smoke.</p> <p>The actions people need to take in case of fire.</p> <p>The necessary information, instruction and training needed and how it will be given.</p>
Smoke alarm	Device containing within one housing all the components, except possibly the energy source, for detecting smoke and giving an audible alarm.
Staged fire alarm	A fire warning that can be given in two or more stages for different purposes within a given area (i.e. notifying staff, stand by to evacuate, full evacuation).
Storey exit	A final exit or a doorway giving direct access into a protected stairway, firefighting lobby, or external escape route.
Travel distance	The actual distance to be travelled by a person from any point within the floor area to the nearest storey exit or final exit, having regard to the layout of walls, partitions and fixings.

Term	Definition
Vision panel	A transparent panel in a wall or door of an inner room enabling the occupant to become aware of a fire in the access area during the early stages.
Way guidance	Low mounted luminous tracks positioned on escape routes in combination with exit indicators, exit marking and intermediate direction indicators along the route, provided for use when the supply to the normal lighting fails, and which do not rely on an electrical supply for their luminous output.
Where necessary	<p>The Order requires that fire precautions (such as firefighting equipment, fire detection and warning, and emergency routes and exits) should be provided (and maintained) 'where necessary'.</p> <p>What this means is that the fire precautions you must provide (and maintain) are those which are needed to reasonably protect relevant persons from risks to them in case of fire. This will be determined by the findings of your risk assessment, including the preventative measures you have or will have taken. In practice, it is very unlikely that a properly conducted fire risk assessment, which takes into account all the matters relevant for the safety of persons in case of fire, will conclude that no fire precautions (including maintenance) are necessary.</p>
Young person	<p>(a) A person aged 16 years, from the date on which he attains that age until and including the 31 August which next follows that date.</p> <p>(b) A person aged 16 years and over who is undertaking a course of full-time education at a school or college which is not advanced education.</p> <p>(c) A person aged 16 years and over who is undertaking approved training that is not provided through a contract of employment.</p> <p>For the purposes of paragraphs (b) and (c), the person:</p> <p>(a) shall have commenced the course of full-time education or approved training before attaining the age of 19 years; and</p> <p>(b) shall not have attained the age of 20 years.</p>

References

The following documents are referenced in this guide. Where dated, only this version applies. Where undated, the latest version of the document applies.

- 1 Regulatory Reform (Fire Safety) Order 2005, SI 2005/1541. The Stationery Office, 2005. ISBN 0 11 072945 5.
- 2 The Fire Precautions (Sub-surface Railway Stations) Regulations 1989, SI 1898/1401. The Stationery Office, 1989.
- 3 The Fire Precautions (Sub-surface Railway Stations) (Amendment) Regulations 1994, SI 1994/2184. The Stationery Office, 1994.
- 4 Fire Precautions Act 1971 (c 40). The Stationery Office, 1971. ISBN 0 10 544071 X.
- 5 Fire Precautions (Workplace) Regulations 1997, SI 1997/1840. The Stationery Office, 1997. ISBN 0 11 064738 6.
- 6 Fire Precautions (Workplace) (Amendment) Regulations 1999, SI 1999/1877. The Stationery Office, 1999. ISBN 0 11 082882 8.
- 7 Licensing Act 2003 (c 17). The Stationery Office, 2003. ISBN 0 10 541703 3.
- 8 The Building Regulations 2000 (as amended 2001).
- 9 *Successful health and safety management*, HSG65. HSE Books, 1997. ISBN 0 7176 1276 7.
- 10 *Safety representatives and safety committees*, L87. HSE Books, 1996. ISBN 0 7176 1220 1.
- 11 *A guide to the Health and Safety (Consultation with Employees) Regulations*, L95. HSE Books, 1996. ISBN 0 7176 1234 1.
- 12 Disability Discrimination Act 1995 (c 50). The Stationery Office, 1995. ISBN 0 10 545095 2.
- 13 Health and Safety (Safety Signs and Signals) Regulations 1996, SI 1996/341. The Stationery Office, 1996. ISBN 0 11 054093 X.
- 14 *Guidance for fire precautions on existing British Rail surface stations*, LFCDA/BR agreement document. LFCDA/BR, February 1993.
- 15 BS 5588-12: *Fire precautions in the design, construction and use of buildings – Part 12: Managing fire safety*. British Standards Institution, 2004.
- 16 Dangerous Substances and Explosive Atmospheres Regulations 2002, SI 2002/2776. The Stationery Office, 2002. ISBN 0 11 042957 5.
- 17 *Dangerous substances and explosive atmospheres. Dangerous Substances and Explosive Atmospheres Regulations 2002. Approved code of practice and guidance*, L138. HSE Books, 2003. ISBN 0 7176 2203 7.
- 18 *The storage of flammable liquids in containers*, HSG51. HSE Books, 1998. ISBN 0 7176 1471 9.
- 19 The Manufacture and Storage of Explosives Regulations 2005, SI 2005/1082. The Stationery Office, 2005. ISBN 0 11 072764 9.
- 20 *Storing and selling fireworks safely*, INDG407. HSE Books, 2005.
- 21 *Safety in the installation and use of gas systems and appliances. Gas Safety (Installation and Use) Regulations 1998. Approved code of practice and guidance*, L56. HSE Books, 1998. ISBN 0 7176 1635 5.
- 22 *Maintaining portable and transportable electrical equipment*, HSG107. HSE Books, 2004. ISBN 0 7176 2805 1.
- 23 The Electricity at Work Regulations 1989, SI 1989/635.
- 24 The Electrical Equipment (Safety) Regulations 1994, SI 1994/3260.
- 25 Construction (Health, Safety and Welfare) Regulations 1996, SI 1996/1592. The Stationery Office, 1996. ISBN 0 11 035904 6.
- 26 *A guide to the Construction (Health, Safety and Welfare) Regulations 1996*, INDG220. HSE Books, 1996. ISBN 0 7176 1161 2.
- 27 The Construction (Design and Management) Regulations 1994 (CONDAM/CDM Regs). HMSO, 1994.
- 28 *Construction Information Sheet No. 51: Construction fire safety*. Health and Safety Executive.
- 29 *Fire safety in construction work*, HSG168. HSE Books, 1997. ISBN 0 7176 1332 1.

- 30 *Fire prevention on construction sites: The joint code of practice on the protection from fire of construction sites and buildings undergoing renovation* (fifth edition). Fire Protection Association and Construction Federation, 2000. ISBN 0 902167 39 1.
- 31 The Furniture and Furnishings (Fire) (Safety) Regulations 1988. The Stationery Office, 1998. ISBN 0 11 087324 6.
- 32 BS 7176: *Specification for resistance to ignition of upholstered furniture for non-domestic seating by testing composites*. British Standards Institution, 1995.
- 33 BS 8300: *The design of buildings and their approaches to meet the needs of disabled people. Code of practice*. British Standards Institution, 2001. ISBN 0 580 38438 1.
- 34 BS 5588-6: *Fire precautions in the design, construction and use of buildings. Code of practice for places of assembly*. British Standards Institution, 1997.
- 35 BS 5839-1: *Fire-detection and alarm systems for buildings. Code of practice for system design, installation, commissioning and maintenance*. British Standards Institution, 2002. ISBN 0 580 40376 9.
- 36 DCLG/CFOA/BFPSA guidance on reducing false alarms.
- 37 BS 5306-8: *Fire extinguishing installations and equipment on premises. Selection and installation of portable fire extinguishers. Code of practice*. British Standards Institution, 2002. ISBN 0 580 33203 9.
- 38 Manual Handling Operations Regulations 1992, SI 1992/2793. The Stationery Office, 1992. ISBN 0 11 025920 3.
- 39 BS EN 3-7: *Portable fire extinguishers. Characteristics, performance requirements and test methods*. British Standards Institution, 2004.
- 40 BS 5306-3: *Fire extinguishing installations and equipment on premises. Code of practice for the inspection and maintenance of portable fire extinguishers*. British Standards Institution. ISBN 0 580 42865 6.
- 41 BS 7863: *Recommendations for colour coding to indicate the extinguishing media contained in portable fire extinguishers*. British Standards Institution, 2003. ISBN 0 580 25845 9.
- 42 BS EN 671-3: *Fixed firefighting systems. Hose systems. Maintenance of hose reels with semi-rigid hose and hose systems with lay-flat hose*. British Standards Institution. ISBN 0 580 34112 7.
- 43 BS EN 12845: *Fixed firefighting systems. Automatic sprinkler systems. Design, installation and maintenance*. British Standards Institution. ISBN 0 580 44770 7.
- 44 BS 5306-2: *Fire extinguishing installations and equipment on premises. Specification for sprinkler systems*. British Standards Institution.
- 45 Workplace (Health, Safety and Welfare) Regulations 1992, SI 1992/3004. The Stationery Office, 1992. ISBN 0 11 025804 5.
- 46 *The Building Regulations 2000: Approved Document B: Fire safety*. The Stationery Office. ISBN 0 11 753911 2.
- 47 Local Government (Miscellaneous Provisions) Act 1982 (c 30). The Stationery Office, 1982. ISBN 0 10 543082 X.
- 48 *The Building Regulations 1991: Approved Document M: Access to and use of buildings* (2004 edition).
- 49 BS 5588-8: *Fire precautions in the design, construction and use of buildings. Code of practice for means of escape for disabled people*. British Standards Institution, 1999.
- 50 BS 5266-8: *Emergency lighting. Code of practice for emergency escape lighting systems*. British Standards Institution.
- 51 BS 5266-1: *Emergency lighting. Code of practice for the emergency lighting of premises other than cinemas and certain other specified premises used for entertainment*. British Standards Institution.
- 52 BS 5499-4: *Safety signs, including fire safety signs. Code of practice for escape route signing*. British Standards Institution, 2000. ISBN 0 580 33205 5.
- 53 BS 5499-5: *Graphical symbols and signs. Safety signs, including fire safety signs. Signs with specific safety meanings*. British Standards Institution, 2002. ISBN 0 580 38259 1.
- 54 BS 7974: *Application of fire safety engineering principles to the design of buildings. Code of practice*. British Standards Institution. ISBN 0 580 38447 0.

- 55 *Successful health and safety management*, HSG65 (second edition). HSE Books, 1997. ISBN 0 7176 1276 7.
- 56 CAP 748: *Air fuelling and fuel installation management*. CAA, July 2004.
- 57 CAP 642: *Airside safety management*. CAA, November 2005.
- 58 CAP 168: *Licensing of aerodromes*. CAA, May 2006.
- 59 *Premises information box*, Statutory Fire Safety Note I005:a4. LFEPA/LFB, June 2005.
- 60 *A guide to best practice in the specification and use of fire-resistant glazed systems*. Glass and Glazing Federation, 2005.
- 61 BS 476-7: *Fire tests on building materials and structures. Method of test to determine the classification of the surface spread of flame of products*. British Standards Institution.
- 62 BS EN 13501-1: *Fire classification of construction products and building elements. Classification using test data from reaction to fire tests*. British Standards Institution.
- 63 *Guidelines for the construction of fire-resisting structural elements*, BR128. Building Research Establishment, 1988.
- 64 *Increasing the fire resistance of existing timber doors*, Information Paper 8/82. Building Research Establishment.
- 65 *Fire-resisting doorsets by upgrading*, Wood Information Sheet 1-32. Timber Research and Development Association.
- 66 BS 4787-1: *Internal and external wood doorsets, door leaves and frames. Specification for dimensional requirements*. British Standards Institution.
- 67 BS EN 1634-1: *Fire resistance tests for door and shutter assemblies. Fire doors and shutters*. British Standards Institution. ISBN 0 580 32429 X.
- 68 BS 476-22: *Fire tests on building materials and structures. Methods for determination of the fire resistance of non-loadbearing elements of construction*. British Standards Institution. ISBN 0 580 15872 1.
- 69 BS EN 1154: *Building hardware. Controlled door-closing devices. Requirements and test methods*. British Standards Institution. ISBN 0 580 27476 4.
- 70 BS EN 1158: *Building hardware. Door co-ordinator devices. Requirements and test methods*. British Standards Institution.
- 71 BS 8214: *Code of practice for fire door assemblies with non-metallic leaves*. British Standards Institution. ISBN 0 580 18871 6.
- 72 BS EN 1125: *Building hardware. Panic exit devices operated by a horizontal bar. Requirements and test methods*. British Standards Institution. ISBN 0 580 28863 3.
- 73 BS EN 179: *Building hardware. Emergency exit devices operated by a lever handle or push pad. Requirements and test methods*. British Standards Institution. ISBN 0 580 28862 5.
- 74 BS 8220-3: *Guide for security of buildings against crime*. British Standards Institution, 2004. ISBN 0 580 23692 7.
- 75 BS 5395-2: *Stairs, ladders and walkways. Code of practice for the design of industrial-type stairs, permanent ladders and walkways*. British Standards Institution. ISBN 0 580 14706 1.
- 76 BS 5588-5: *Fire precautions in the design, construction and use of buildings. Access and facilities for firefighting*. British Standards Institution.
- 77 BS 5266-6: *Emergency lighting. Code of practice for non-electrical low-mounted way-guidance systems for emergency use. Photo-luminescent systems*. British Standards Institution.
- 78 BS 5306-1: *Fire extinguishing installations and equipment on premises. Hydrant systems, hose reels and foam inlets*. British Standards Institution.
- 79 BS EN 1155: *Building hardware. Electrically powered hold-open devices for swing doors. Requirements and test methods*. British Standards Institution.
- 80 BS 5839-3: *Fire-detection and alarm systems for buildings. Specification for automatic release mechanisms for certain fire-protection equipment*. British Standards Institution. ISBN 0 580 15787 3.

- 81 *Storage of full and empty LPG cylinders and cartridges. Code of practice 7.* LP Gas Association, 2000. Available from LP Gas Association, Pavilion 16, Headlands Business Park, Salisbury Road, Ringwood, Hampshire BH24 3PB.
- 82 *Hardware for timber fire and escape doors.* BHIF, 2000.
- 83 BS EN 12209: *Building hardware. Locks and latches. Mechanically operated locks, latches and locking plates.* British Standards Institution.
- 84 BS EN 1906: *Building hardware. Lever handles and furniture. Requirements and test methods.* British Standards Institution.
- 85 BS EN 1935: *Building hardware. Single-axis hinges. Requirements and test methods.* British Standards Institution. ISBN 0 580 39272 4.
- 86 BS EN 1634-2: *Fire resistance tests for door and shutter assemblies. Part 2. Fire door hardware. Building hardware for fire-resisting doorsets and openable windows.* British Standards Institution.

Index

Page numbers in italics refer to information in Figures or Tables.

A

access for firefighters 27, 28, 66–7, 68, 123, 132, 133, 134, 143
 airport terminals 4
 escape routes 21, 31, 71, 72, 77, 124–5
 fire-detection and warning systems 25, 26, 61
 fire risk assessment 117–20
 management planning 124–5
 alarms *see* fire detection and warning systems
 alterations 10, 13, 16, 44, 48, 53–4, 62, 67, 74, 143
 alterations notices 7, 9, 12, 38, 40, 45, 54, 145
 animals 18
 arson 15, 16, 19, 23, 49, 50, 56
 assembly points 43, 122, 127, 129–30
 automatic fire detection systems 25, 54, 58–9, 60–1, 81, 83, 87, 96, 99, 110, 140, 142, 145

B

basements 51, 84, 85, 93, 101, 105–8, 111, 136, 145
 building management systems 59–60
 building work 10, 45, 53–4
 bus/coach terminals and stations 4, 19, 56, 72

C

candles 22
 cavity barriers 136
 ceilings
 fire-resisting 30, 33, 55, 136
 lining materials 17, 23, 73, 136, 137–8, 145
 children 7, 18, 145, 149
 evacuating 28, 29, 56, 96, 122
 close down procedures 121, 122, 127
 co-operation and co-ordination 7, 8, 39, 40, 42, 67, 127, 135
 competent persons 5, 7, 13, 145
 electrical safety 51
 emergency escape lighting 112, 134
 escape routes 32, 70, 87, 100, 101, 102, 103, 104, 133
 fire-resisting separation 30, 137
 firefighting equipment and facilities 36, 133, 134
 conduction, fire spreading by 20
 construction, fire-resisting 29–30, 49, 55, 76, 79–81, 86, 90, 93, 101–2, 108, 123, 136–8, 147
 contingency plans 121, 122, 126

contractors

certifying 36, 131, 141
 fire safety training 7, 41, 42
 managing 53–4
 permit to work 54
 risk to 26, 123
 source of ignition 54
 convection, fire spreading by 20
 cooking 52, 54, 61, 64, 65, 123
 crowd control 32, 74, 122

D

dangerous substances 7, 8, 16, 17, 42, 43, 49, 127, 146
 storage 23, 50–2, 55
 transport of 51, 124
 dead ends
 escape routes 73, 78, 81, 82–3, 146
 fire alarms 81
 detonators 21, 23, 51
 disability *see* people with special needs
 Disability Discrimination Act 1995 56
 display materials 17, 22, 44, 50
 doors
 door-fastenings 31, 35, 36, 72, 95, 116, 127, 132, 133, 138, 141–2
 door furniture 138, 139–41
 final exit 30, 33, 95–6
 fire-resisting 37, 44, 54, 55, 67, 84, 86, 92, 93, 94, 101, 138–42, 146
 glazing 139
 maintenance 8, 21, 35, 36, 37, 48, 132, 133, 134, 141
 metal 139
 notices 35, 95, 113, 114, 142
 revolving 95
 roller shutter doors 69, 95, 133
 self-closing 55, 69, 72, 86, 92, 101, 108, 114, 133, 134, 140, 148
 sliding 95
 turnstiles 95
 vision panels 138, 149
 wicket 95

E

electrical safety 15, 19, 22, 48, 49, 50, 51, 52–3, 64, 68, 121

emergency escape lighting 32, 33–4, 37, 72, 94, 111–12, 121, 146

- auxiliary power supply 34
- tests, checks and maintenance 35, 36, 112, 116, 132, 133, 134
- torches 33, 36

emergency plans 31, 38, 39, 40, 47, 48, 116, 121–5, 127, 128, 129, 135

equipment and machinery 15, 19, 22, 43, 44, 49, 52, 64, 121, 123

escalators and travelators 32, 59, 72, 93, 123, 125

escape routes 28–33, 147

- age and construction of the premises 29–30, 55
- alternative exits 30, 31–2, 73, 77, 79, 80, 82, 84, 87, 96, 98, 145
- basements 84, 85, 93, 101, 105–8, 111, 145
- compartmentation 25, 37, 71, 73, 125, 133, 134
- corridors 12, 31, 54, 72, 73, 75, 86, 87, 88, 108, 109
- dead ends 73, 78, 81, 82–3, 146
- emergency lighting 32, 33–4, 37, 72, 94, 111–12, 121, 146
- escape time 21, 29, 33, 70, 71, 72, 76
- final exits 28, 30, 33, 64, 77, 89, 95–6, 106, 146
- inner rooms 78, 80, 145, 147, 149
- layouts 70, 96–110
- levels of risk 30, 70–1, 78–9
- lifts 31, 43, 72, 76, 93, 121, 122, 133, 146
- lobbies 67, 75, 87, 88, 108, 109, 148
- maintenance 8, 31, 33, 35, 36, 92, 94
- managing 30–1, 33, 48, 49, 73, 142
- number required 30, 37, 77, 96, 127, 141
- obstructions 30, 31, 33, 36, 49, 54, 72, 96, 132
- people with special needs 21, 28, 29, 31, 33, 44, 57, 74–6, 121
- ramps 31, 76
- reception areas 91
- roof exits 94
- signs and notices 30, 34, 35, 73, 111, 113–15, 133
- suitability 72–3
- tests and checks 36, 37, 132, 133, 134
- training 41, 43, 128
- travel distance 25, 30, 31, 55, 59, 70–1, 73–4, 77–80, 82, 96, 100–2, 104–6, 148
- type and number of people using premises 29, 30, 33, 57, 72, 74, 80, 96, 101, 105–6
- widths and capacity of 30, 37, 72, 76–7, 95

see also doors; stairways

European Directives 6, 10

evacuation

- managed 24, 60, 123
- phased 26, 66, 122, 147
- progressive horizontal 31, 57, 125
- single stage 66
- strategy 43, 56–7, 60, 70–1

extinguishers 26–8, 35, 36, 63–5, 114, 116, 132, 133

F

false alarms 26, 59, 60–1, 116, 146

ferry terminals 4, 31, 71

fire

- classes of 63–4
- spread of 13, 16, 17, 20–1, 33, 35, 49, 55–6, 93, 137

fire blankets 65, 116

fire certificates 6, 55

fire detection and warning systems 25–6, 37, 58–62

- alarm receiving station/centre 59, 62, 124, 129, 132
- automatic fire detection systems 25, 54, 58–9, 60–1, 81, 83, 87, 96, 99, 110, 140, 142, 145
- auxiliary power supply 26, 59, 62
- building management systems and 59–60
- false alarms 26, 59, 60–1, 116, 146
- manual call points 25, 58–9, 61, 62, 121, 129, 140
- monitoring 26, 36, 44, 56, 58, 59, 62, 121, 124
- phased evacuation 26
- quality assurance 131
- record-keeping 37, 62, 116
- smoke detectors 26, 61, 80, 140, 148
- sound levels 26, 30, 58
- specifications 61
- staff alarms 59, 60, 61
- staged alarms 61, 148
- tests and checks 8, 35, 36, 37, 59, 61–2, 116, 129, 132, 133, 134
- visual alarms 58, 60, 133
- voice alarms 25, 56, 58, 60, 123, 133

fire drills 43, 44, 116, 123, 129

fire marshals 27, 43, 125, 128–9, 143

fire plans box 121, 123, 126

fire policy manual 116, 143

fire-resisting separation 54, 73, 91, 136–8

fire risk assessment

- aims 11
- co-operation and co-ordination 7, 8, 39, 40, 42, 67, 127, 135
- emergency plans 31, 38, 39, 40, 47, 48, 116, 121–5, 127, 128, 129, 135
- evaluating risk 11, 14, 19–21, 38, 70–1, 78, 127

- Fire Safety Order and 4, 6–10, 12, 13, 116, 149
 - flexibility 24–5
 - historic buildings 5, 143–4
 - identifying fire hazards 11, 14, 15–18, 38, 117–20, 135
 - identifying people at risk 14, 37, 38, 70–1, 117–20, 127, 135
 - information and instruction 7, 8, 34–5, 38, 39, 41, 42, 48, 60, 113–15, 121, 125–7, 135
 - method 12–13
 - plan of action 47, 56–7
 - record-keeping 4, 7, 9, 12, 14, 38–40, 45, 116, 117–20, 135
 - removing or reducing fire hazards 11, 22–4, 32, 38, 47, 49, 56, 117–20, 135
 - removing or reducing risk to people 5, 37, 38, 47, 56
 - reviewing 10, 14, 44–5, 121, 135
 - sources of fuel 15, 16–17, 23, 31, 37, 49–52, 56, 73, 117, 119
 - sources of ignition 15–16, 19, 22–3, 31, 37, 51, 52–4, 56, 73, 117, 119
 - sources of oxygen 15, 17–18, 24, 37, 117, 119
 - fire safety audit 116, 121
 - fire safety management 5, 11, 19, 47–8, 53–4, 142
 - Fire Safety Order 4, 6–10, 12, 13, 116, 149
 - fire safety strategy 66, 76, 116, 128, 147
 - fire stopping 55, 86, 137, 147
 - fire suppression systems 32, 36, 44, 49, 65–6, 116, 123, 133
 - automatic 24, 27, 67, 71, 121
 - firefighters' switches 35, 66, 68, 134
 - firefighting equipment and facilities 26–8, 37
 - access for firefighters 27, 28, 66–7, 68, 123, 132, 133, 134, 143
 - extinguishers 26–8, 35, 36, 63–5, 114, 116, 132, 133
 - fire plans box 121, 123, 126
 - fire pumps 36, 65, 69
 - firefighters' switches 35, 66, 68, 134
 - firefighting lifts and shafts 28, 31, 66, 67, 76, 93, 103, 125, 133, 146
 - foam inlets 27, 68
 - gas flooding systems 27
 - hose reels 36, 65, 116
 - hydrants 63, 69, 132, 133, 134
 - maintenance 8, 27, 28, 35–7, 65–6, 67, 68–9, 116, 132, 133, 134
 - quality assurance 131
 - record-keeping 27, 116
 - rising mains 27, 66, 67–8, 121, 134
 - signs 27, 34, 35, 66, 69, 114
 - tests and checks 65, 68, 132, 133, 134
 - training 27, 41, 43, 63, 65, 125
 - see also* fire suppression systems
 - fireworks 17, 23, 24, 51, 52
 - flame-retardant materials 50, 56, 73, 123
 - flammable liquids 16, 23, 50–1, 52, 56, 63, 64, 147
 - flares 17, 23, 51
 - floors
 - covering materials 17, 23, 30, 73
 - fire-resisting 30, 33, 55, 94, 136, 137, 145
 - foam, fire risk of 16
 - foam inlets 27, 68
 - fuel, sources of 15, 16–17, 23, 31, 37, 49–52, 56, 73, 117, 119
 - fuel tanks 51, 124
 - furniture and furnishings 16, 17, 22, 44, 54, 55–6
- G**
- gas cylinders 17, 24, 50, 51, 54
 - see also* LPG
 - gas flooding systems 27
 - glass, fire-resisting 137, 139
- H**
- hazard
 - definition 12
 - identifying fire hazards 11, 14, 15–18, 38, 117–20, 135
 - removing or reducing 11, 22–4, 32, 38, 47, 49, 56, 117–20, 135
 - hazardous materials 5, 23, 35, 44, 125, 127, 143, 147
 - Health and Safety Executive (HSE) 5, 9, 13
 - heating 15, 19, 22, 50, 52, 54, 60
 - historic buildings 5, 143–4
 - hose reels 36, 65, 116
 - hotels 4
 - housekeeping 43, 48, 49
- I**
- ignition, sources of 15–16, 19, 22–3, 31, 37, 51, 52–4, 56, 73, 117, 119
 - information and instruction 7, 8, 34–5, 38, 39, 41, 42, 48, 60, 113–15, 121, 125–7, 135
- L**
- ladders 93
 - leased premises 8, 47
 - licensed premises 6, 7, 12, 38, 40, 147
 - lifts
 - escape routes 31, 43, 72, 76, 93, 121, 122, 133, 146
 - firefighting 28, 31, 66, 67, 76, 93, 103, 125, 133, 146
 - management planning 125
 - lighting 15, 19, 37, 50, 60, 112, 115
 - lightning 15
 - lowering lines 93

LPG 16, 19, 51, 52, 54
luminaires 111, 112, 132, 133, 134

M

maintenance
 checklist 132–4
 emergency escape lighting 35, 36, 112, 116, 132, 133, 134
 equipment and machinery 22, 52, 53
 escalators and travelators 125
 escape routes 8, 31, 33, 35, 36, 92, 94
 fire detection and warning systems 8, 35–7, 59, 61–2, 116, 132, 133, 134
 fire doors 8, 21, 35, 36, 37, 48, 132, 133, 134, 141
 firefighting equipment and facilities 8, 27, 28, 35, 36, 37, 65–6, 67, 68–9, 116, 132, 133, 134
mezzanine floors 55, 97, 99
multi-occupied buildings 7
 co-operation and co-ordination 40, 42, 67
 escape routes 70, 87, 94
 fire detection and warning systems 25, 60
 fire risk assessment 5, 8, 13, 19
 information and instruction 48, 60, 114

N

naked flame 15, 22, 54
non-English speakers 7, 18, 41, 117, 119, 125

O

Office of Rail Regulation (ORR) 5, 13
offices 4, 5, 12, 59, 70, 123
oxygen, sources of 15, 17–18, 24, 37, 117, 119

P

partitions, fire-resisting 30, 54, 136, 137
 see also walls
passengers, fire risk assessment 18, 70–1, 117–20, 122–5
people at risk
 evaluating 20–1, 37, 70–1, 78
 identifying 14, 18–19, 37, 38, 117–20, 127, 135
 removing or reducing risk 5, 37, 38, 47, 56, 78, 117–20, 135
 restricting the spread of fire and smoke 55–6
 type and number using premises 29, 30, 33, 44, 57, 72, 74, 80, 96, 101, 105–6
people with special needs
 evacuating 21, 28, 29, 31, 44, 56–7, 74–6, 121, 122, 128, 129
 fire risk assessment 7, 13, 14, 18, 21, 49, 56–7, 127
 fire warning systems 26, 40, 60
 information and instruction 40, 112, 113
 risk to 18, 44

personal emergency evacuation plans (PEEPs) 29, 57
phased evacuation 26, 66, 122, 147
piping 17, 22, 52, 54
plans and specifications 39, 121
portable appliance testing (PAT) 53
ports 4
progressive horizontal evacuation 31, 57, 125
public address systems 59, 60, 123
pyrotechnics 17, 23, 24

R

radiation, fire spreading by 20
rail terminals, stations and platforms 4, 48
 escape routes 21, 31, 33, 71, 72, 73–4, 77
 fire-detection and warning systems 25, 26, 59, 61
 fire safety training 43
 management planning 122–3
 sub-surface facilities *see* underground facilities
ramps 31, 76
reception areas 91
record-keeping
 emergency escape lighting 112, 116
 fire detection and warning systems 37, 62, 116
 fire risk assessment 4, 7, 9, 12, 14, 38–40, 45, 116, 117–20, 135
 fire safety training 44, 128
 firefighting equipment and facilities 27, 116
refuge areas 31, 57, 75, 76, 121, 148
rising mains 27, 66, 67–8, 121, 134
risk
 definition 12
 evaluating 11, 14, 19–21, 37, 38, 70–1, 78, 127
 people at risk 14, 18–19, 37, 38, 70–1, 117–20, 127, 135
 reducing 5, 14, 24–37, 38, 47, 78, 117–20
roll calls 127, 129–30
roller shutter doors 69, 95, 133
rolling stock 21, 73
roof exits 94

S

security 35, 56, 141, 142
shafts, firefighting *see* lifts
shared use *see* multi-occupied buildings
shops 4, 5, 17, 71, 123
signs and notices 27, 30, 34–5, 37, 69, 73, 111, 113–15, 133
 information and instruction 41, 66, 95, 121, 142
single stage evacuation 66
smoke
 control of 25, 33, 36, 49, 55–6, 66, 67, 71, 73, 134

dangers of 21
 spread of 20–1, 22, 35, 73, 86, 93

Smoke and Heat Exhaust Ventilation Systems (SHEVS) 25, 55, 59, 67, 71, 122, 134

smoke detectors 26, 61, 80, 140, 148

smoking 15, 19, 22, 53, 61

sprinklers 24, 27, 32, 36, 49, 65–6, 67, 71, 121, 123, 133

staff

- fire drills 43, 44, 116, 123, 129
- fire safety training 7, 8, 26, 30, 38, 39, 41, 42–4, 122, 125, 128–30, 142
- firefighting training 27, 41, 43, 63, 65, 125, 129
- information and instruction 7, 8, 34–5, 38, 39, 41, 42, 48, 114, 125–7, 135
- roles in emergency 121, 128
- staff alarms 59, 60, 61
- staff numbers 57, 71, 121, 123, 141
- see also* contractors

stairlifts 76

stairways

- accommodation stairways 87, 91, 145
- basements 84, 85, 93, 101, 105–8
- bypass routes 90, 91
- external 92, 146
- hazards in 12, 31, 49, 54, 72, 87
- protected 28, 32, 75, 77, 87, 88–9, 90, 92, 96, 100, 104, 108, 148
- spiral and helical 93
- width and capacity of 32, 77

standby diesel engines 36, 65

stations *see* rail terminals

storage 16, 23, 49–52, 54, 55

- racking 73

T

telephones 34, 35, 66, 127

terrorism 15, 122

torches 33, 36

training

- fire safety 7, 8, 26, 30, 38, 39, 41, 42–4, 122, 125, 128–30, 142
- firefighting equipment 27, 41, 43, 63, 65, 125, 129
- record-keeping 44, 128

trains, fire emergencies and 16, 122–3

transport interchanges 4, 13, 40, 71

transport management planning 122–5

tunnels 4

- escape routes 31, 55, 123, 124
- management planning 123–4

U

underground facilities

- escape routes 31, 33, 55, 73, 77
- fire detection and warning systems 59
- fire-resisting separation 136, 138
- fire safety management 47
- management planning 122–3
- ventilation systems 17

undergrowth, trimming 52, 56

V

vandalism 23, 27, 65

vehicles 4, 53

ventilation systems 17, 21, 24, 55, 59, 60, 122, 134

vision panels 80, 138, 148

voids 55, 78, 137, 143

W

walls

- fire-resisting 30, 33, 55, 67, 92, 123, 136–7, 145
- lining materials 17, 30, 73, 136, 137–8, 145
- see also* partitions

waste and packaging, combustible 16, 19, 23, 49, 50, 53, 55, 56, 125

way guidance systems 32, 34, 112

windows, fire-resisting 92, 94, 137, 139

- vision panels 80, 138, 148

This guide is for employers, managers, occupiers and owners of transport premises and facilities. It tells you what you have to do to comply with fire safety law, helps you to carry out a fire risk assessment and identify the general fire precautions you need to have in place.

The guides in this series:

Guide	Main use
 <i>Offices and shops</i> ISBN-13: 978 1 85112 815 0	Offices and retail premises (including individual units within larger premises, e.g. shopping centres).
 <i>Factories and warehouses</i> ISBN-13: 978 1 85112 816 7	Factories and warehouse storage premises.
 <i>Sleeping accommodation</i> ISBN-13: 978 1 85112 817 4	All premises where the main use is to provide sleeping accommodation, e.g. hotels, guest houses, B&Bs, hostels, residential training centres, holiday accommodation and the common areas of flats, maisonettes, HMOs and sheltered housing (other than those providing care – see Residential care premises), but excluding hospitals, residential care premises, places of custody and single private dwellings.
 <i>Residential care premises</i> ISBN-13: 978 1 85112 818 1	Residential care and nursing homes, common areas of sheltered housing (where care is provided) and similar premises, which are permanently staffed and where the primary use is the provision of care rather than healthcare (see Healthcare premises).
 <i>Educational premises</i> ISBN-13: 978 1 85112 819 8	Teaching establishments ranging from pre-school through to universities, except the residential parts (see Sleeping accommodation).
 <i>Small and medium places of assembly</i> ISBN-13: 978 1 85112 820 4	Smaller public houses, clubs, restaurants and cafés, village halls, community centres, libraries, marquees, churches and other places of worship or study accommodating up to 300 people.
 <i>Large places of assembly</i> ISBN-13: 978 1 85112 821 1	Larger premises where more than 300 people could gather, e.g. shopping centres (not the individual shops), large nightclubs and pubs, exhibition and conference centres, sports stadia, marquees, museums, libraries, churches, cathedrals and other places of worship or study.
 <i>Theatres, cinemas and similar premises</i> ISBN-13: 978 1 85112 822 8	Theatres, cinemas, concert halls and similar premises used primarily for this purpose.
 <i>Open air events and venues</i> ISBN-13: 978 1 85112 823 5	Open air events, e.g. theme parks, zoos, music concerts, sporting events (not stadia – see Large places of assembly), fairgrounds and county fairs.
 <i>Healthcare premises</i> ISBN-13: 978 1 85112 824 2	Premises where the primary use is the provision of healthcare (including private), e.g. hospitals, doctors' surgeries, dentists and other similar healthcare premises.
 <i>Transport premises and facilities</i> ISBN-13: 978 1 85112 825 9	Transportation terminals and interchanges, e.g. airports, railway stations (including sub-surface), transport tunnels, ports, bus and coach stations and similar premises but excluding the means of transport (e.g. trains, buses, planes and ships).

ISBN-13: 978 1 85112 825 9

Price: £12

ISBN 978185112825-9



9 781851 128259 >